

Polski Rejestr Statków

RULES

PUBLICATION NO. 45/P

FATIGUE STRENGTH ANALYSIS OF STEEL HULL STRUCTURE

1998

**(Consolidated text incorporating
Amendments No. 1/2005,
status on 15 December 2005)**

Publications P (Additional Rule Requirements) issued by Polski Rejestr Statków complete or extended the Rules and are mandatory where applicable.



GDAŃSK

Publication No. 45/P – Fatigue Strength Analysis of Steel Hull Structure, 1998 is an extension of the requirements set forth in Part II – Hull, 1996 of the Rules for the Classification and Construction of Sea-going Ships.

The Publication, considered and accepted by the PRS Technical Committee on 19th of October, 1998, was approved by PRS Director General on 15th of February 1999 and enters into force on 1st of June 1999.

© Copyright by Polski Rejestr Statków, 1998

PRS/TW, 03/99

CONTENTS

	Page
1 General	5
1.1 Application and Methods of Fatigue Strength Analysis	5
1.2 Definitions and Explanations.....	6
2 Simplified fatigue strength calculations of hull structural members	7
2.1 Calculation Algorithm	7
2.2 Stress Range Calculations.....	8
2.3 Long-Term Stress Range Distribution.....	25
2.4 Welded Joints Classification. S-N Curves.....	26
2.5 Modification of S-N Curves	31
2.6 Calculation of Fatigue Strength.....	32
3 Direct calculation of fatigue strength	39
3.1 General.....	39
3.2 Short-Term Prediction of Stress Range	39
3.3 Long-Term Prediction of Stress Range	40
3.4 Fatigue Strength Calculation	42
4 Calculation of stresses using finite element method	43
4.1 Principles of Stress Calculation	43
4.2 Calculation of Hot-Spot Stresses	44
4.3 Calculation of Stresses having Regard to Weld Dimensions and Shape	46

1 GENERAL

1.1 Application and Methods of Fatigue Strength Analysis

1.1.1 The present Publication is an extension of the requirements, set forth in Part – II Hull of the Rules for the Classification and Construction of Sea-going Ships, by the provisions relating to the fatigue strength analysis of steel welded hull structural members.

1.1.2 The fatigue strength standard, specified in the Publication, as well as the recommended calculation methods enable to assess whether the proposed hull design solutions satisfy the fatigue life requirements (usually the 20 year lifetime) and to correct, where necessary, the proposed solutions of various structural details.

1.1.3 The present Publication contains requirements for the fatigue strength analysis of hull structures subject to variable in time (pulsating) stresses, induced by the inertia forces of cargo, ship structure and equipment due to the ship motions in waves and sea dynamic pressures.

1.1.4 Variable stresses in hull structural members due to structure vibrations generated by the main and auxiliary machinery, propeller and machinery installations installed on board, vibrations due to wave dynamic loads and slamming and sloshing loads, as well as stresses generated by temperature change of hull structural members are disregarded in the present Publication.

1.1.5 The fatigue strength calculations are to include, depending on the ship type, the following hull structural members made from higher strength steel:

- .1** for single hull tankers:
 - connections of side longitudinals and longitudinal bulkheads with transverse frames and transverse bulkheads,
 - brackets of longitudinal and transverse girders;
 - the edges of openings and cut-outs in girders;
- .2** for double hull tankers:
 - connections of the inner side slope sections with the inner bottom plating and the plating vertical portions of inner sides;
 - welded joints of transverse girder webs with the inner side plating and the inner bottom plating at edges of plating;
 - connections of the inner and outer hull longitudinal stiffeners with girders or transverse bulkheads;
 - brackets of longitudinal and transverse girders;
 - the edges of openings and cut-outs in primary members;
- .3** for container ships and ships other than container ships adapted to the carriage of containers:
 - cargo hatchway corners,
 - connections of stringer plate to sheer strake;
 - connections of the plating longitudinal stiffeners with transverse frames or transverse bulkheads;
- .4** for bulk carriers:
 - side frames brackets,
 - connections of bulkhead corrugations and connections of bulkhead stool plating with the upper plates of the stool;
 - connections of bulkhead stool plating with the inner bottom plating;
 - connections of hopper tank plating with the inner bottom plating and floors;
 - cargo hatchway corners,
 - brackets at the ends of longitudinal hatch coamings.

The calculations are to show whether the fatigue strength of the above-mentioned structural members satisfies the criteria set forth in the present Publication.

1.1.6 PRS may also require that the fatigue strength calculations should be made for structural members and ship types other than those listed in 1.1.5 – depending on the structure specific features, dynamic loads, to which the structure is subjected, as well as the steel yield stress.

1.1.7 Fatigue strength calculation method, required in the present Publication, refers to the so-called high cycle fatigue strength. Calculations are made using Palmgren-Miner law and S-N curves (2.3.4).

PRS may accept the results of calculations made using the methods of fatigue crack gap propagation analysis. For gap increase description, the application of Paris law is recommended.

1.1.8 The fatigue strength of hull structural members may be calculated using a simplified method, in accordance with Chapter 2. However, this method may yield underrated values of fatigue life – particularly in the case of those structural members, which are subject to combined stresses due to hull bending or hull girder torsion and local bending – generated by sea or cargo pressures.

1.1.9 Calculation method consisting in direct calculation of the long-term stress distribution using the so-called spectral analysis (Chapter 3) and the calculation of stresses at the notches – in accordance with the requirements of 4.2, particularly in cases specified in 3.1.1 and 4.1.1, is recommended.

1.1.10 The methods of fatigue strength calculations, required in the present Publication, are based on the assumption that the quality of welded joints and the workmanship tolerances do not depart from the acceptable shipbuilding practice.

1.2 Definitions and Explanations

1.2.1 Definitions and abbreviations used in the present Publication:

DEN – the British institution dealing with, inter alia, steel structures safety.

Long-term distribution of stress ranges – density function of stress range probability, determined for the predicted ship operational life.

Regular wave – two-dimensional wave on sinusoidal water surface, described by the ideal fluid potential flow.

Transfer function – the value of hull response amplitude (e.g. stresses in the selected point of structure) to loads in regular wave of unit amplitude.

IIW – International Institute of Welding – an international institution dealing with welding issues.

FEM – finite element method.

Hot-spot stresses – the values of stresses at the notch, calculated by the finite element method using a special method of results extrapolation or stress concentration factors determined for nominal stresses.

Nominal stresses – the stresses calculated using hull structural members beam or rod models or coarse FEM models.

Short-term prediction – probability distribution of hull response parameter (e.g. stresses in the structure) in stationary seaway conditions with the assumed values of significant wave height and the characteristic wave period.

Rules – Rules for the Classification and Construction of Sea-going Ships.

Fatigue life – the structure capability to withstand dynamic loads, measured against its service life, after which fatigue cracks are expected to initiate.

Fatigue damage – dimensionless factor used in Palmgren-Miner hypothesis to evaluate (measure) cumulative damage.

Hull midship portion – the ship portion equal to $0.4 L_0$, symmetrical in relation to the midship section (where L_0 – design length of the ship, defined in the Rules).

1.2.2 Symbols used in the present Publication:

C – stress concentration factor;

C_e – stress concentration factor resulting from assembling inaccuracy;

C_n – stress concentration factor in the flange of asymmetrical stiffener (girder);

C_w – stress concentration factor for bracket connections of plating longitudinal stiffeners (girders);

D – fatigue damage;

$g = 9,81 \text{ m/s}^2$ – acceleration of gravity;

$k_{pr} = (0,5)^{1/\xi}$ – dimensionless factor adjusting the values of load to the magnitudes exceeded with 10^{-4} probability;

ξ – Weibull distribution factor approximating the long-term stress range distribution (calculated according to 2.3.3);

L_0 – design length of the ship, [m], (defined in the Rules);

$\text{Min}(a, b)$ – a or b , whichever is the lesser;

$\text{Max}(a, b)$ – a or b , whichever is the greater;

R_e – steel yield stress, [MPa];

$\rho = 1,025 \text{ t/m}^3$ – sea water density;

$\Delta\sigma$ – stress range, [MPa];

$\Delta\sigma_g$ – the resultant global stress range, [MPa];

$\Delta\sigma_l$ – the resultant local stress range, [MPa];

$\Delta\sigma_r$ – the stress range resulting from the superposition of global and local stresses, [MPa].

2 SIMPLIFIED FATIGUE STRENGTH CALCULATIONS OF HULL STRUCTURAL MEMBERS

2.1 Calculation Algorithm

2.1.1 Definition of Stress Range

A single cycle of pulsating stresses, which may cause fatigue cracks of hull structural members, is defined in Fig. 2.1.1.

The basic parameter determining the fatigue life of structural members are $\Delta\sigma$ values of nominal or hot-spot stress ranges in particular cycles of stresses, i.e. the differences between the maximum value σ_{\max} and the next minimum value σ_{\min} (Fig. 2.1.1).

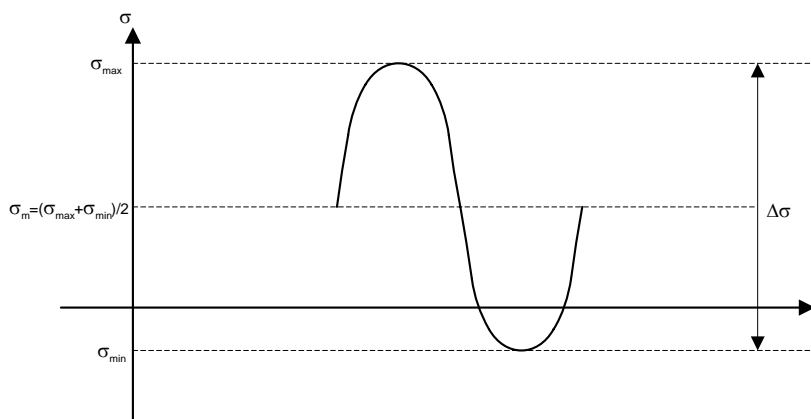

Fig. 2.1.1 Single cycle load

2.1.2 Fatigue Strength Calculation Method

2.1.2.1 Simplified calculations are based on the assumption that the long-term distribution of stress ranges in the considered structural member has the form of Weibull distribution and on the application of S-N curves and Palmgren–Miner Law.

The sequence of calculations is to be as follows:

- the stress range is to be calculated according to the requirements of 2.2.2÷2.2.9;
- Weibull distribution parameters are to be determined according to the requirements of 2.3;
- S-N curve is to be selected according to the requirements of 2.4;
- S-N curve is to be modified according to the requirements of 2.5;
- fatigue strength criterion is to be checked – according to 2.6.5.

2.1.2.2 It has been assumed in the present Publication that the stress range values used directly in simplified calculations of structural members fatigue strength are exceeded with 10^{-4} probability.

2.2 Stress Range Calculations

2.2.1 General

2.2.1.1 Fatigue cracks of structural members usually occur in areas of local stress concentration in hull longitudinal members in which instantaneous values of dynamic stresses due to horizontal and vertical hull bending stresses, hull torsion, as well as local bending stresses due to sea pressures (external pressures) or the pressures or inertia forces of cargo or hull equipment (internal pressures) are superposed.

Examples of such fatigue cracks areas:

- welded joints of longitudinal stiffeners with girders or transverse bulkheads;
- discontinuity (notches) on hull plating or stiffeners (welded-on doubling plates, ends of intermittent welds, change in the thickness of plating, change in the flange width, etc.);
- cargo hatchway corners.

2.2.1.2 Fatigue cracks may also occur in transverse structural members – e.g. on cut-outs edges in girders or in way of brackets.

Transverse members are usually subject to superposition of dynamic components of stresses generated by external sea pressures and cargo inertia forces (internal forces).

2.2.1.3 The method of calculating particular components of stress ranges is given in 2.2.2 ÷ 2.2.7; the method of calculating the resultant stress range, used directly in checking the fatigue strength criterion in accordance with 2.6.5, is given in 2.2.9.

2.2.2 Stress Range due to Hull Vertical Bending

2.2.2.1 The value of nominal stress range in hull plating, longitudinal girders or stiffeners is to be calculated from the formula:

$$\Delta\sigma_v = k_{pr} \frac{|M_{ww}| + |M_{wu}|}{W_V} k_{wm} \cdot 10^3, \text{ [MPa]} \quad (2.2.2.1)$$

where:

k_{pr} – as defined in 1.2.2;

M_{ww}, M_{wu} – the values of wave bending moments amidships, in sagging and hogging conditions, calculated according to 15.5, Part II–Hull of the Rules, [kNm];

k_{wm} – dimensionless coefficient determining the wave moment distribution, defined in 15.5.2.2, Part II – Hull of the Rules;

W_V – hull section modulus related to horizontal neutral axis, $\left(W_V = \frac{I_V}{|z - z_0|} \right)$, [cm³];

I_V – moment of inertia of the hull cross-section, [cm⁴];

z_0 – coordinate of neutral axis on vertical axis of the ship, [cm],

z – coordinate of the point where $\Delta\sigma_v$ is calculated on vertical axis of the ship, [cm].

2.2.2.2 I_V is to be calculated in accordance with 15.7, Part II – Hull of the Rules, for design thicknesses of structural members, i.e. without deduction of corrosion additions.

2.2.3 Stress Range due to Hull Horizontal Bending

2.2.3.1 The value of nominal stress range in hull plating, longitudinal girders or stiffeners is to be calculated from the formula:

$$\Delta\sigma_H = 2k_{pr} \frac{M_{wh} k_{wh}}{W_H} \cdot 10^3, [\text{MPa}] \quad (2.2.3.1)$$

where:

k_{pr} – as defined in 1.2.2;

M_{wh} – the values of horizontal wave bending moment amidships, calculated according to 15.5.3, Part II – Hull of the Rules, [kNm];

$k_{wh} = \frac{1}{2} \left(1 + \cos \frac{2\pi x}{L_0} \right)$ – coefficient determining distribution of horizontal wave bending moment along the ship's length;

x – coordinate on longitudinal axis of the ship; $x = 0$ amidships, [m];

L_0 – design ship's length, [m];

$W_H = \frac{I_H}{|y|}$ – hull section modulus related to horizontal neutral axis, [cm³];

I_H – moment of inertia of the hull cross-section, [cm⁴];

y – coordinate of the point where $\Delta\sigma_H$ is calculated on horizontal axis ($y = 0$ in the hull centre plane), [cm].

2.2.3.2 I_H is to be calculated for design thicknesses of structural members, i.e. without deduction of corrosion additions. Calculations are to be made in accordance with 15.7, Part II – Hull of the Rules.

2.2.4 Loads for Determining Stress Ranges due to Local Bending of Plating, Stiffeners or Girders

2.2.4.1 General

Local bending is generated by external sea pressures and internal loads due to cargo and equipment.

In 2.2.4, the method of determining the values of dynamic pressures and hull accelerations in waves, used subsequently in calculations of dynamic stresses in hull structural members due to local bending, is given.

The method of calculating nominal stresses in plating, stiffeners and girders used subsequently for the fatigue strength assessment according to 2.6, directly or after the application of stress concentration factors (2.2.8) and their superposition in accordance with 2.2.9, is given in 2.2.5 ÷ 2.2.7.

2.2.4.2 Range of External Dynamic Pressures

The range of external dynamic pressures, defined in a way analogous to stress range definition (2.1.1), acting on the ship's bottom or side in the bottom area, is to be determined from the formula:

$$\Delta p_z = 2 k_{pr} p_{db}, [\text{kPa}] \quad (2.2.4.2)$$

where:

k_{pr} – as defined in 1.2.2;

p_{db} – external sea dynamic pressure acting on the ship's bottom or side, calculated according to 16.2.2.1, Part II – Hull of the Rules;

Δp_z on the ship's side, in the waterline region, in the loading condition under consideration is to be calculated according to 2.2.4.3.

2.2.4.3 Range of External Dynamic Pressures on the Ship's Side, in the Waterline Region

The ship's side in the waterline region – due to hull motions with respect to the water surface – is partially wetted.

The range of dynamic loads on the ship's side, at a distance $z > T_1 - T_d$ from the base plane (Fig. 2.2.4.3), is to be calculated from the formula:

$$\Delta p_z = 2k_{pr} k_d p_{db}, [\text{kPa}] \quad (2.2.4.3-1)$$

where:

k_{pr} – as defined in 1.2.2;

k_d – coefficient, as shown in Fig. 2.2.4.3;

p_{db} – external sea dynamic pressure acting on the ship's side ($z > T_1 - T_d$), calculated according to 16.2.2.1 ÷ 16.2.2.3, Part – Hull of the Rules, for the real ship's draught $T=T_1$ in the considered loading condition, [kPa].

T_d denotes the value of the amplitude of the water level dynamic displacements in relation to the waterline in the considered loading condition, exceeded with 10^{-4} probability. T_d is to be calculated from the formula:

$$T_d = \frac{k_{pr} p_{db}^*}{\rho g}, [\text{m}] \quad (2.2.4.3-2)$$

k_{pr}, ρ, g – as defined in 1.2.2;

$p_{db}^* = p_{db}(z = T_1)$ – dynamic pressure at the waterline level, calculated for $T=T_1$ according to 16.2.2.1, Part II – Hull of the Rules.

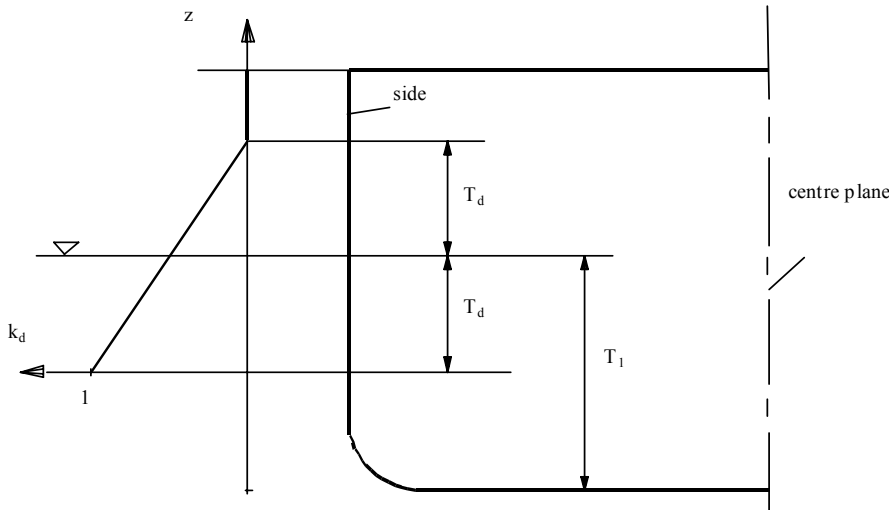

Fig. 2.2.4.3 The value of coefficient k_d

Below the level $z = T_1 - T_d$ (Fig. 2.2.4.3), Δp_z is to be calculated according to 2.2.4.2.

2.2.4.4 Range of Dynamic Pressures due to Liquid Cargo or Ballast

The range Δp_w of dynamic pressures acting on the side or bottom of the liquid cargo or ballast tank is to be taken as the maximum value of the following three values:

$$\Delta p_L = 2k_{pr} \rho a_L l, [\text{kPa}] \quad (2.2.4.4-1)$$

$$\Delta p_T = 2k_{pr} \rho a_T b, [\text{kPa}] \quad (2.2.4.4-2)$$

$$\Delta p_V = 2k_{pr} \rho a_v h, [\text{kPa}] \quad (2.2.4.4-3)$$

where:

k_{pr} – as defined in 1.2.2;

ξ – Weibull distribution coefficient, calculated according to 2.3.3;

ρ – liquid cargo or ballast density, [t/m^3], (1.025 t/m^3 is to be taken for ballast);

a_L, a_T, a_v – longitudinal, transverse and vertical accelerations in geometric centre of the area bounded by the bottom, top, side, as well as the nearest wash bulkheads (transverse or longitudinal) or the tank boundaries where there are no wash bulkheads, [m/s^2].

The values of a_L, a_T, a_v are to be calculated according to 17.4 of Part II – Hull of the Rules.

l – half-length of the area defined above, [m];

b – half-width of the area defined above, [m];

h – vertical distance from the point, in which pressure ranges are determined, to the liquid surface level, [m].

Where the resultant range of pressures occurring on the common boundary of the adjacent tanks is determined, the values of Δp_L and Δp_T , determined separately for each tank, are to be summed up and the value of Δp_V is to be deducted.

2.2.4.5 Range of Dynamic Pressures due to Bulk Cargo

The range of dynamic pressures generated by bulk cargo on the bottom or boundaries of bulk carrier or ore carrier cargo hold is to be taken as follows:

$$\Delta p_w = 2 k_{pr} \rho a_v h K, [\text{kPa}] \quad (2.2.4.5)$$

where:

k_{pr} – as in 2.2.2.1;

ρ – density of bulk cargo, [t];

a_v – vertical acceleration, calculated in accordance with 17.4.1, Part II – Hull of the Rules, [m/s²];

h – vertical distance to the cargo surface in hold, [m]. It may be assumed that the cargo surface is a plane parallel to the base plane;

K – coefficient defined according to 16.4.2.1, Part II – Hull of the Rules.

2.2.4.6 Dynamic Loads Generated by Unit Cargo or Ship Equipment

– The components of forces induced by unit cargo or ship equipment on the hull structure, used subsequently in determining stress ranges in plating, stiffeners or girders are to be calculated from the formulae:

– vertical force:

$$\Delta P_V = 2 k_{pr} a_v M, [\text{kN}] \quad (2.2.4.6-1)$$

– transverse force:

$$\Delta P_T = 2 k_{pr} a_T M, [\text{kN}] \quad (2.2.4.6-2)$$

– longitudinal force:

$$\Delta P_L = 2 k_{pr} a_L M, [\text{kN}] \quad (2.2.4.6-3)$$

where:

k_{pr} – as defined in 1.2.2;

a_v, a_T, a_L – vertical, transverse and longitudinal accelerations in the centre of gravity of cargo unit or ship equipment, calculated in accordance with 17.4, Part II – Hull of the Rules, [m/s²];

M – cargo unit or the ship equipment element mass, [t].

2.2.5 Range of Stresses Induced by Local Bending of Plating

2.2.5.1 The values of nominal normal stress ranges in shell plates and in welded joints areas, necessary for the assessment of the joints fatigue strength, are to be calculated according to the requirements set forth in 2.2.5.2 and 2.2.5.3.

The method of the above stress ranges superposition to the other components is given in 2.2.9.

2.2.5.2 The maximum values of the resultant ranges of local stresses in the centres of rectangular contour of the plate with $l/s > 2$, loaded uniformly over the whole surface (l, s – the lengths of the plate longer and shorter side, [m]), are to be calculated according to the formulae:

– in the centre of the plate longer side:

$$\Delta \sigma_l = 500 \Delta p_R \left(\frac{s}{t} \right)^2, [\text{MPa}] \quad (2.2.5.2-1)$$

– in the centre of the plate shorter side:

$$\Delta \sigma_s = 309 \Delta p_R \left(\frac{s}{t} \right)^2, [\text{MPa}] \quad (2.2.5.2-2)$$

where:

Δp_R – the resultant range of pressures, calculated according to 2.2.9.2, [kPa];

t – the plate thickness, [mm]. It is the design plate thickness, except where the plates may be directly exposed to corrosive action of sea water – in such case the value t is to be taken in accordance with 2.6.4.

2.2.5.3 Where $l/s \leq 2$ or where the plate cannot be considered as clamped at the edges, solutions resulting from the bending theory of rigid plates, provided in literature, are to be directly applied in lieu of formulae given in 2.2.5.2.

2.2.6 Range of Stresses Induced by Local Bending of Stiffeners

2.2.6.1 General

The values of nominal normal stress ranges in the flanges of stiffeners induced by local bending are necessary for the assessment of the fatigue life of stiffeners welded connections with girders, bulkheads, other stiffeners, as well as in the areas of flanges discontinuities (e.g. welded-on doubling plate, changes in the flange width or thickness, etc.).

Depending on the type of S-N curve used in the calculations and the shape of stiffener (symmetrical or asymmetrical), it may be required that the values of nominal stresses should be multiplied by stress concentration factors, determined according to the requirements of 2.2.8 or 4.2 and then combined with stresses due to local bending or hull torsion and girder bending – according to the requirements of 2.2.9.

In stress range calculations according to the principles given in 2.2.6, the stiffener beam model, including the effective strip of plating, is used.

2.2.6.2 Stress Calculation Method

When calculating the bending moment in stiffeners, account is to be taken of the influence of the adjacent spans on the span under consideration.

The design span of stiffeners is to be determined in accordance with 3.2.1, Part II – Hull of the Rules.

The width of the effective strip of plating, taken into account in calculations of the stiffener section modulus, is to be determined according to 2.2.6.3.

The stiffener section modulus is to be calculated for as built scantlings of transverse cross-section or as built scantlings reduced by corrosion allowances – in accordance with 2.6.4.

2.2.6.3 Width of Effective Strip of Plating

For longitudinal stiffeners of plating subjected to sea water pressure, liquid or bulk cargo or water ballast, the breadth s_e , [m], of the effective strip of plating is to be calculated as follows:

in mid-point of the span:

$$- \text{ for } \frac{l}{s} < 2,5: \quad \frac{s_e}{s} = 0,27 + 0,23 \frac{l}{s} \quad (2.2.6.3-1)$$

$$- \text{ for } 2,5 \leq \frac{l}{s} \leq 3,5: \quad \frac{s_e}{s} = 0,73 + 0,05 \frac{l}{s} \quad (2.2.6.3-2)$$

$$- \text{ for } \frac{l}{s} > 3,5: \quad \frac{s_e}{s} = 0,90 \quad (2.2.6.3-3)$$

at the span ends, i.e. at the connections of stiffener with girders or transverse bulkheads:

$$- \text{ for } \frac{l}{s} \leq 2,5: \quad \frac{s_e}{s} = 0,47 + 0,13 \frac{l}{s} \quad (2.2.6.3-4)$$

$$- \text{ for } \frac{l}{s} > 2,5: \quad \frac{s_e}{s} = 0,80 \quad (2.2.6.3-5)$$

In the above formulae, l denotes the stiffener span, [m], (determined in accordance with 3.2.1, Part II – Hull of the Rules) and s denotes the stiffeners spacing, [m].

In other cases, the value of the effective strip of plating is to be determined in accordance with 3.2.2, Part II – Hull of the Rules.

2.2.6.4 Bending of Plating Longitudinal Stiffeners

The range of nominal stresses generated by stiffener local bending due to sea water pressure and ballast water or liquid cargo pressure (internal pressure) is to be calculated in accordance with 2.2.6.5.

For stiffener spans located in close vicinity of transverse bulkheads, the ranges of stresses resulting from the bending of girders supporting the stiffeners, calculated according to 2.2.6.6, are to be algebraically added to the ranges of stresses calculated in accordance with 2.2.6.5.

2.2.6.5 The stiffener model is a prismatic beam with the length l , [m], with both ends fixed and uniformly loaded with pressure p , [kPa].

The stiffener bending moment is a parabolic function of longitudinal coordinate, taking the following values:

– at the span ends:

$$M_1 = \frac{psl^2}{12}, \text{ [kNm]} \quad (2.2.6.5-1)$$

– in mid-point of the span:

$$M_2 = \frac{psl^2}{24}, \text{ [kNm]} \quad (2.2.6.5-2)$$

where:

s – stiffeners spacing, [m].

The stress range is to be calculated from the formula:

$$\Delta\sigma = 10^3 \frac{\Delta M}{W}, \text{ [MPa]} \quad (2.2.6.5-3)$$

where:

ΔM – the value of M_1 or M_2 , calculated according to formulae 2.2.6.5-1 or 2.2.6.5-2, substituting $p = \Delta p_R$, [kPa];

Δp_R – the resultant range of pressures calculated according to 2.2.9.2 for the ranges of external and internal pressures, calculated according to 2.2.4.2 ÷ 2.2.4.4, [kPa];

W – the stiffener section modulus, including the effective strip of plating, [cm³].

2.2.6.6 Bending moments in the end cross-sections of the stiffener span l , [m], located in close vicinity of transverse bulkhead, induced by the bending f of the girder supporting the stiffener, take the values of opposite sign, but of the same absolute value:

$$M = 10^{-8} \frac{6EI}{l^2} f, \text{ [kNm]} \quad (2.2.6.6)$$

where:

E – Young's module, [MPa];

I – moment of inertia of the stiffener, including the effective strip of plating, [cm⁴];

l – stiffener span, [m].

Bending moment varies linearly along the span.

The stress range $\Delta\sigma$ is to be calculated according to formula 2.2.6.5-3 for ΔM obtained from formula 2.2.6.6. When calculating ΔM , the value of f , determined for the resultant pressure range Δp_R , is to be substituted into formula 2.2.6.6. Δp_R is to be determined according to 2.2.9.2 for the values of external and internal pressure ranges, calculated according to 2.2.4.2 ÷ 2.2.4.4.

When calculating f , the principles of modelling hull girders system of different ship types, given in the following PRS Publications, are to be used:

- Publication No. 18/P – Zone Strength Analysis of Bulk Carrier Hull Structure;
- Publication No. 19/P – Zone Strength Analysis of Hull Structure in Tankers;
- Publication No. 24/P – Strength Analysis of Container Ship Hull Structure.

Δp_R considered as design pressure of girders is to be applied externally if $\Delta p_z > \Delta p_w$ (see 2.2.4.2÷2.2.4.5) and internally if $\Delta p_z < \Delta p_w$.

2.2.7 Range of Stresses due to Girders Bending

2.2.7.1 General

The values of stress ranges due to bending of girders are required to assess the fatigue strength of girders weld connections with other girders (e.g. bracket connections), flange notch areas (e.g. change of the flange thickness) and the edges of cut-outs in web plates.

The calculations of girders provide also the values of stress ranges in the plating stiffeners located in way of the effective strip of plating.

2.2.7.2 Stress Calculation Method

The ranges of stresses in areas susceptible to fatigue cracks may be determined by means of modelling the girder system as 2-dimensional framework or grillage using the principles given in PRS Publications relating to fatigue strength analysis of various types of ships (the relevant Publications are given in 2.2.6). Another approach may be to utilize stress concentration factors, given in 2.2.8 or to calculate the fatigue life on the basis of nominal stress ranges – using the appropriate S-N curve selected according to 2.4.

2.2.8 Stress Concentration Factors

2.2.8.1 General

To obtain the resultant range of hot-spot stresses, stress concentration factors, determined in accordance with the requirements of 2.2.8, are to be multiplied by the components of nominal stress ranges, determined according to 2.2.2 ÷ 2.2.7. The obtained values are to be superposed in accordance with the requirements of 2.2.9. When determining the components of nominal stress ranges, account is to be taken of the influence of the shape and dimensions of the structure basic elements on the stresses in structural members subject to fatigue strength check. For example, the influence of large openings in side or deck plating on the stresses in the plating longitudinal members located near the openings is to be taken into account.

The resultant hot-spot stress ranges and S-N “D” curve (para. 2.4) are used to calculate the structural members fatigue strength – in accordance with the requirements of 2.6.

The fatigue strength of simple structural members may be verified by direct application of nominal stress ranges – after selection of the appropriate S-N curve according to the principles given in 2.4.

When calculating the fatigue strength of structural members for which stress concentration factors are not provided in 2.2.8.3 and 2.2.3.4 or in the case of complex FEM analysis of hull structure, the ranges of hot-spot stresses are to be calculated directly – according to the principles given in 4.2.

2.2.8.2 Stress Concentration Factors in Asymmetrical Flanges

The bending of stiffeners/girders with asymmetrical flange and symmetrical effective strip of plating generates a non-uniform distribution of normal stresses in the flange (Fig. 2.2.8.2).

This effect is to be taken into account in the fatigue strength calculations of flange weld connection with brackets at the ends of stiffeners/girders spans, connection with doubling plates, etc.

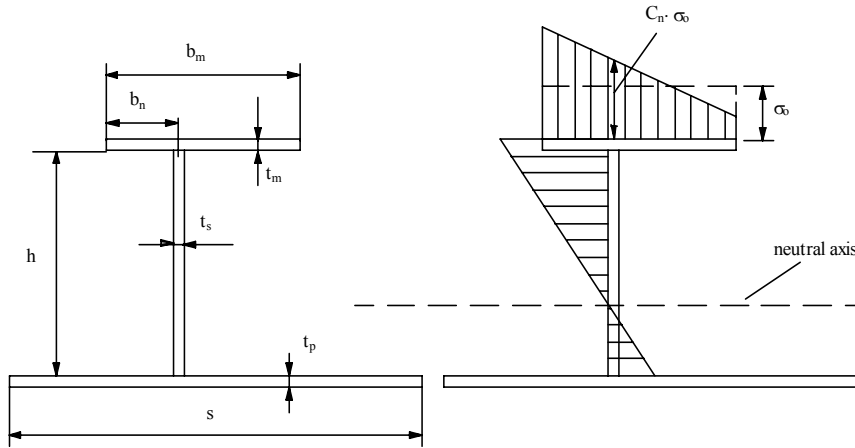

Fig. 2.2.8.2 Scantlings of stiffener and distribution of normal stresses at bending

The values of stress concentration factor C_n (in the web plate plane) are defined in Fig. 2.2.8.2, where σ_0 denotes the value of normal stresses in flange at bending, calculated for symmetrical flange.

The approximate values of C_n may be calculated from the formulae:

$$- \text{ for } 0 \leq \frac{b_n}{b_m} \leq 0,3: \quad C_n = (2,32 - 3,33 \frac{b_n}{b_m}) C_k \quad (2.2.8.2-1)$$

$$- \text{ for } 0,3 < \frac{b_n}{b_m} \leq 0,5: \quad C_n = [1 + 8,5(\frac{b_n}{b_m} - 0,5)^2] C_k \quad (2.2.8.2-2)$$

where:

C_k – factor obtained from the formula:

$$C_k = 1 + \ln\left(\frac{b_m t_m}{h t_s}\right) \left(0,5 - \frac{b_n}{b_m}\right)^2 \quad (2.2.8.2-3)$$

Units used in formulae 2.2.8.2-1 ÷ 2.2.8.2-3 are to be taken in millimeters. They are defined in Fig. 2.2.8.2.

Factors C_n , calculated according to formulae 2.2.8.2-1 ÷ 2.2.8.2-3, may be used in the fatigue strength analysis of plating longitudinal stiffeners subjected to sea water pressure (external pressure) or the liquid, bulk cargo, or ballast water pressure (internal pressure).

In other cases, the values of factors C_n are to be directly obtained from FEM calculations, in accordance with 4.2.

FEM calculations may be also made for longitudinal stiffeners of plating. So calculated C_n may be used in lieu of those obtained from formulae 2.2.8.2-1 ÷ 2.2.8.2-3.

2.2.8.3 Stress Concentration Factors for Stiffeners and Girders Connected by Brackets

The values of nominal stress ranges $\Delta \sigma_n$ in stiffener/girder flanges due to local bending or tension/compression are multiplied by the values of stress concentration factors C_w , given in the present paragraph. For stiffeners/girders with asymmetrical flange, stress ranges are to be additionally multiplied by stress concentration factor $C_n > 1$, determined in accordance with 2.2.8.2 ($C_n = 1$ in the case of symmetrical flange). Where in potential fatigue cracks areas (see Table 2.2.8.3) transverse shift additionally occurs, the stress ranges are to be additionally multiplied by stress concentration factor C_e , determined in accordance with 2.5.5. $C_e = 1$ where transverse shift of structural member is neglected.

The total stress concentration factor is to be determined from the formula:

$$C = C_n C_w C_e \quad (2.2.8.3-1)$$

$C \Delta \sigma_n$ products, determined for different stress concentration components, superposed according to 2.2.9, constitute hot-spot stresses range applied directly to fatigue strength calculations – in accordance with 2.6.

C_w factors may take different values for bending and tension conditions. The values of $\Delta\sigma_n$ are to be calculated for areas of potential fatigue cracks, indicated in Table 2.2.8.3. The value of $\Delta\sigma_n$ due to local bending is to be calculated from the formula:

$$\Delta\sigma_n = \frac{\Delta M}{W} \cdot 10^3, [\text{MPa}] \quad (2.2.8.3-2)$$

where:

ΔM – bending moment range, [kNm],

W – the stiffener section modulus related to the upper surface of the flange, calculated taking into account the effective strip of plating of the width determined according to formulae 2.2.6.3-4, 2.2.6.3-5, [m³].

The bending moment range is to be calculated from the formulae:

– for points A, as given in Table 2.2.8.3:

$$\Delta M = \frac{\Delta p_R s l^2}{12}, [\text{kNm}] \quad (2.2.8.3-3)$$

– for points B, as given in Table 2.2.8.3:

$$\Delta M = \frac{\Delta p_R s l^2}{12} - \frac{1}{2} \Delta p_R s l u + \frac{1}{2} \Delta p_R s u^2, [\text{kNm}] \quad (2.2.8.3-4)$$

where:

Δp_R – the resultant range of pressures acting on the plating, [kPa], calculated in accordance with 2.2.9.2;

s – spacing of stiffeners, [m];

l – spacing of transverse girders supporting the stiffener or the girder and bulkhead spacing, [m];

u – distance of points B (Table 2.2.8.3) from the girder web, [m].

The values of coefficients C_w , given in Table 2.2.8.3, may be applied to typical dimensions and dimension proportions of strip of plating, stiffener (or girder) web and flange, the stiffener of transverse girder or transverse bulkhead web, as well as brackets connecting the stiffener with plating (or girder) stiffener flange.

However, it is recommended that hot-spot stresses in areas of potential fatigue cracks are calculated directly according to the requirements of 4.2. Direct calculation method allows to design structures that can give better economics.

Direct calculation method will be required by PRS with respect to joints not covered by Table 2.2.8.3, as well as to joints similar to those given in the Table, but having dimensions and dimension proportions considered as not typical.

Table 2.2.8.3
Values of stress concentration factors C_w

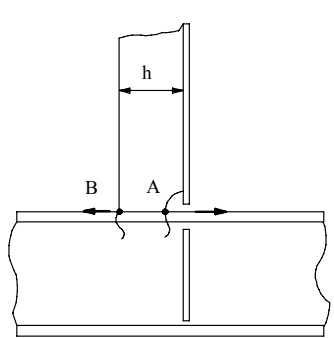
Item	Type of joint	C_w			
		Tension (compression)		Bending	Comments
1	2	3		4	5
1		<p>H C_w</p> <p>[mm] p. A p. B</p> <p>100 1,33 1,22</p> <p>140 1,38 1,28</p> <p>180 1,43 1,33</p> <p>220 1,46 1,37</p>	<p>$..h$ C_w</p> <p>[mm] p. A p. B</p> <p>.100 2,07 1,04</p> <p>.200 2,18 1,36</p>	(1), (2)	

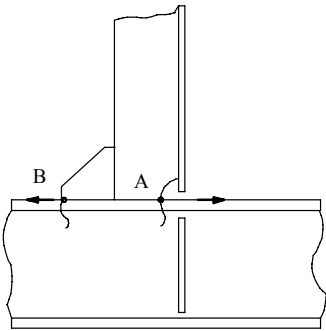
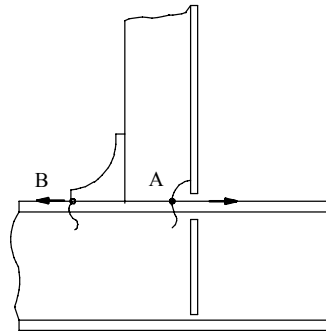
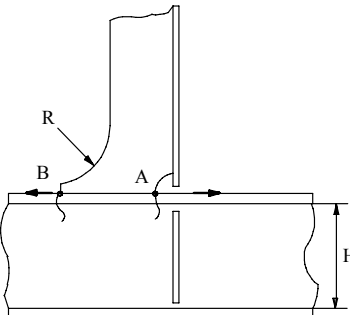
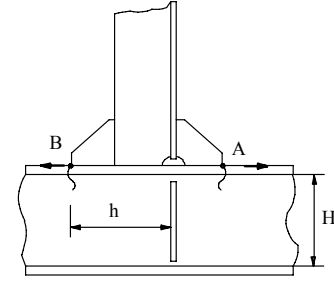
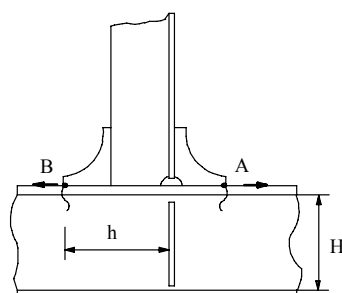
1	2	3	4	5
2		<p>p. A: $C_W = 1,72$ p. B: $C_W = 1,60$</p>	<p>p. A: $C_W = 2,20$ p. B: $C_W = 1,75$</p>	(1), (2)
3		<p>p. A: $C_W = 1,65$ p. B: $C_W = 1,50$</p>	<p>p. A: $C_W = 2,20$ p. B: $C_W = 1,60$</p>	(1), (2)
4		<p>p. A: $C_W = 1,60$ p. B: $C_W = 1,45$</p>	<p>p. A: $C_W = 2,15$ p. B: $C_W = 1,50$</p>	<p>C_W values are valid for $R \geq 0,5H$</p> <p>(1), (2)</p>
5		<p>p. A: $C_W = 1,78$ p. B: $C_W = 1,78$</p>	<p>p. A: $C_W = 2,75$ p. B: $C_W = 2,65$</p>	<p>C_W values are valid for $0,75 \leq \frac{h}{H} \leq 1,0$</p> <p>(1)</p>
6		<p>p. A: $C_W = 1,52$ p. B: $C_W = 1,52$</p>	<p>p. A: $C_W = 1,50$ p. B: $C_W = 1,75$</p>	<p>C_W values are valid for $0,75 \leq \frac{h}{H} \leq 1,0$</p> <p>(1)</p>

1	2	3	4	5
7		p. A: $C_w = 1,67$ p. B: $C_w = 1,61$	p. A: $C_w = 2,20$ p. B: $C_w = 1,66$	C_w values are valid for $0,5 \leq \frac{h}{H} \leq 1,0$ (1), (2)
8		p. A: $C_w = 1,54$ p. B: $C_w = 1,46$	p. A: $C_w = 2,10$ p. B: $C_w = 1,50$	C_w values are valid for $0,5 \leq \frac{h}{H} \leq 1,0$ (1), (2)
9		p. A: $C_w = 1,80$ p. B: $C_w = 1,80$	p. A: $C_w = 2,70$ p. B: $C_w = 2,70$	C_w values are valid for $0,5 \leq \frac{h}{H} \leq 1,0$ (1)

Notes to Table 2.2.8.3:

- (1) The Table gives the approximate values of C_w . They apply to typical dimensions and dimension proportions of plating longitudinal stiffeners and their connections with transverse girders or bulkheads.
- (2) If in joints, given in items 1, 2, 3, 4, 7 and 8 in point A area, a cut-out (scallop) having a special shape, indicated in Fig. 2.2.8.3, is applied, the values of C_w for tension and compression, given in the Table, are to be changed as follows:
- in point A area – are to be reduced by 5%;
 - in point B area – are to be reduced by 2%.
- The values of C_w for local bending remain unchanged.

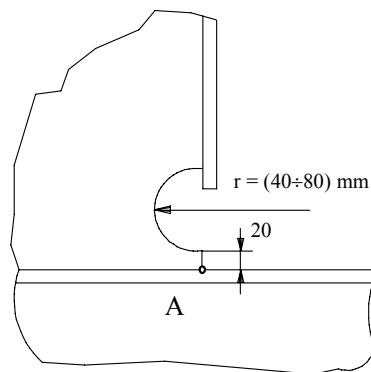

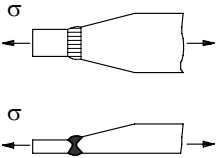



Fig. 2.2.8.3

2.2.8.4 Stress Concentration Factors for Typical Hull Structure Welded Joints

The values of stress concentration factors C_d adapted to sea dynamic loads acting on the ship's hull, specified in IIW proceedings, are given Table 2.2.8.4. The values of nominal stress ranges, given in Table 2.2.8.4, are to be multiplied by the values of C_d . Then, the fatigue strength is to be calculated in accordance with 2.6. For stiffeners/girders with asymmetrical flanges subject to bending, the stress ranges are to be additionally multiplied by coefficient C_n , determined in accordance with 2.2.8.2 (for σ calculated as for a beam with symmetrical flange).

Table 2.2.8.4
Stress concentration factors for typical hull structure welded joints

Nr Item	Joint	Description of joint and information on stresses	C_d
A TRANSVERSE BUTT WELDS			
1		Butt weld on steel backing strip, not removed after welding	1,24
2		Butt weld on ceramic backing strip	1,10
3		Connection of three plates	1,24
4		Full penetration butt weld, without backing strip: - root of weld inspected by NDT ⁽¹⁾ → - root of weld not inspected →	1,24 1,95
5		Partial penetration butt weld. Stresses are to be calculated for the actual weld cross-section, excluding weld reinforcements. Note: It is recommended that the result of fatigue strength calculations be multiplied by fracture mechanics methods.	1,95
6		Butt weld, weld reinforcement ground flush, the weld inspected by NDT, thickness and width reduction: 1 : 5 ——— 1 : 3 ——— 1 : 2 ———	0,70 0,88 1,10
7		Butt weld performed on prefabrication, in downhand position, weld reinforcement check, the weld inspected by NDT, thickness and width reduction: 1 : 5 ——— 1 : 3 ——— 1 : 2 ———	0,88 0,98 1,10

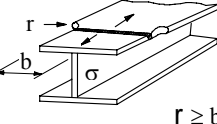
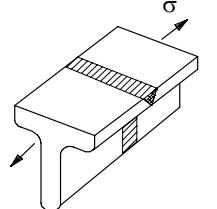
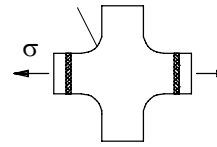
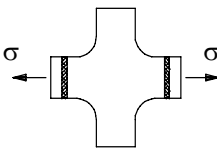
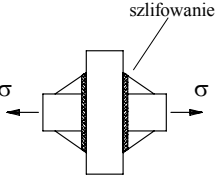
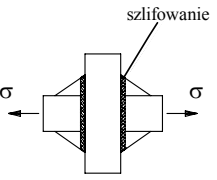
Nr Item	Joint	Description of joint and information on stresses	C_d
8		<p>Butt weld, the weld inspected by NDT. Thickness and width reduction:</p> <p>1 : 5 </p> <p>1 : 3 </p> <p>1 : 2 </p>	1,10 1,24 1,39
9		<p>Butt weld between plates of different thicknesses, parallel, without misalignment.</p> <p>Note: Where the shape of the weld face is equivalent to beveling of plate edges, the appropriate value of C_d is to be taken according to item 7.</p>	1,24
10		<p>Butt weld of flange in prefabricated beam, weld reinforcement ground flush, smooth transition by grinding, the weld inspected by NDT.</p>	0,78
11		<p>Butt weld of rolled section (except flat bar), weld reinforcement ground to rod thickness, the weld inspected by NDT.</p>	1,10
12	<p>krawędzie szlifowane</p> 	<p>Butt weld, the welds ground flush, the ends of welds and the edges of plates ground. Smooth transition by diamond plate. The weld inspected by NDT.</p>	0,70
13		<p>Butt weld performed on prefabrication, in downhand position, weld reinforcement check, the weld inspected by NDT. Smooth transition by diamond plate.</p>	0,88
14		<p>Butt weld, weld reinforcements ground flush and inspected by NDT. Triangle brackets at the ends of flanges, the ends of brackets ground.</p> <p>The value of C_d refers to fatigue crack in butt weld.</p>	1,10
15		<p>Butt weld, the weld inspected by NDT. Triangle brackets at the ends of flanges, the ends of brackets ground.</p> <p>The value of C_d refers to fatigue crack in butt weld.</p>	1,24

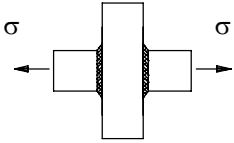
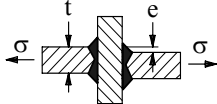
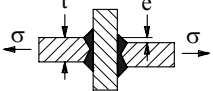
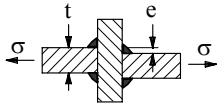
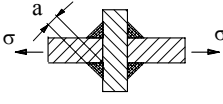
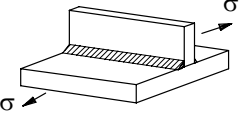
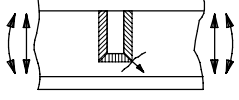
Nr Item	Joint	Description of joint and information on stresses	C_d
16		Butt weld of crossing flanges. The value of C_d refers to fatigue crack in butt weld.	1,75
B CRUCIFORM AND TEE JOINTS			
17		Cruciform or tee joint, full penetration butt welds (type K), plates resistant to lamellar tearing, misalignment $e < 0,15 t$, the surface of the welds ground. The value of C_d refers to fatigue crack on the weld surface.	1,10
18		Cruciform or tee joint, full penetration butt welds (type K), plates resistant to lamellar tearing, misalignment $e < 0,15 t$. The value of C_d refers to fatigue crack on the weld surface.	1,24
19		Cruciform or tee joint, fillet welds, plates resistant to lamellar tearing, misalignment $e < 0,15 t$. The value of C_{od} refers to fatigue crack on the weld surface.	1,39
20		Cruciform or tee joint, fillet welds. The value of C_d refers to fatigue crack in the root of the weld. Note: for calculation of nominal stresses, the weld thickness "a" is to be used.	1,95
C NON-LOAD CARRYING ELEMENTS CONNECTED WITH LOAD CARRYING MEMBER			
21		Non-carrying load transverse plate welded to the main plate; transverse plate thinner than the main plate. Welds and the welds treatment: – butt weld, type K; the weld surface ground: – double-sided fillet weld; the weld surface ground: – fillet welds, grounding not applied: When the plate connected to the main plate is thicker:	0,88 0,88 1,10 1,24
22		Transverse frame welded to the stiffener/girder web or flange, with the thickness smaller than that of the girder walls. For fatigue crack in the web or flange in way of the transverse plate top, C_d determined for the values σ and τ in this area, calculated according to thin-walled beam theory is to be used. The value of C_d , depending on the weld type and treatment: – butt weld, type K, the weld surface ground, – double-sided fillet weld, the weld surface ground – fillet weld, without treatment. Where the transverse frame is thicker than the main plate:	0,88 0,88 1,10 1,24

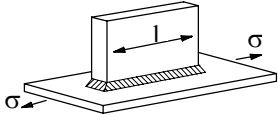
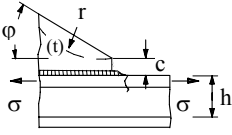
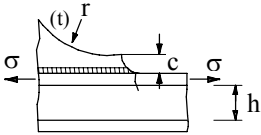
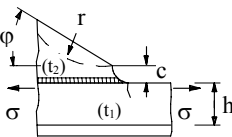
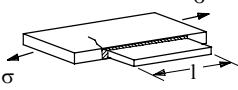
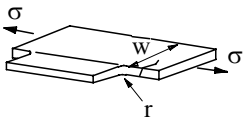
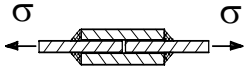
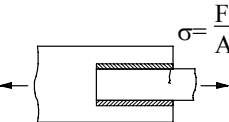
Nr Item	Joint	Description of joint and information on stresses	C_d
23		Longitudinal plate, fillet welded to the main plate. The values of C_d , depending on the plate length $l \leq 50$ mm: $l \leq 150$ mm: $l \leq 300$ mm: $l > 300$ mm:	1,10 1,24 1,39 1,75
24		Fillet weld of bracket to beam or plate flange. The bracket with a rounded edge and the following conditions are met: $c < 2t$, max. 25. The values of C_d depending on r : $r > 0.5 h$: $r < 0.5 h$ albo $\varphi > 20^\circ$	1,24 1,39
25		Fillet weld of the bracket, the bracket end rounded. The fillet weld end thickened and grounded. The following conditions are met: $c < 2t$, max. 25 mm; $r > 150$ mm	0,98
26		The bracket welded along the edge of plate or beam web. The bracket with a rounded edge and the following conditions are met: $c < 2t_2$ (max. 25 mm). The values of C_d depending on r and φ : $r > 0.5 h$: $r < 0.5 h$ or $\varphi < 20^\circ$: Note: when $t_2 < 0,7 t_1$, the above values of C_d may be reduced by 7%.	1,75 1,95
27		Strip welded along the edge of plate or beam flange. The values of C_d depending on the strip side length: $l \leq 150$ mm: $l \leq 300$ mm: $l > 300$ mm:	1,75 1,95 2,19
28		Strip welded along the edge of plate or beam flange. The plate ends rounded. The values of C_d depending on r and w : $r > 150$ mm or $r/w > 1/3$: $1/6 < r/w < 1/3$: $r/w < 1/6$:	0,98 1,24 1,75
D LAP AND DOUBLER JOINTS			
29		Lap joint, transverse fillet welded. Parent metal fatigue crack: Weld fatigue crack:	1,39 1,95
30		Doubling plate, longitudinal fillet welded. Parent metal fatigue crack: Weld fatigue crack (assuming that the lengths of the welds are 40 times their thicknesses:	1,75 1,75

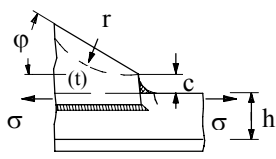
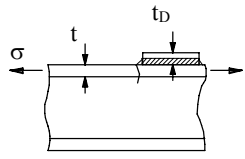
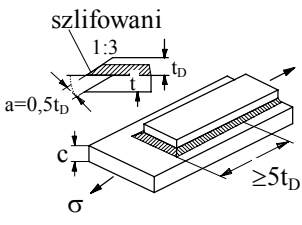
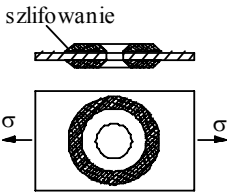
Nr Item	Joint	Description of joint and information on stresses	C_d
31		Bracket with undercutting ($\varphi < 20^\circ$) or with a rounded edge, satisfying the conditions: $c < 2 t$, max. 25 mm, lap welded to: – flat bar: – bulb bar: – angle bar :	1,39 1,57 1,75
32		The end of a long doubling plate welded to beam flange (based on stresses in flange, at the weld edge). The values of C_d , depending on t/t_D : $t_D < 0,8 t$: $0,8 t \leq t_D < 1,5 t$: $t_D \geq 1,5 t$:	1,57 1,75 1,95
33		The end of a long doubling plate welded to beam flange. The welds at the ends of the doubling plate strengthened and grounded (based on the values of stresses in flange, at the weld edge). The values of C_d , depending on t/t_D : $t_D < 0,8 t$: $0,8 t \leq t_D < 1,5 t$: $t_D \geq 1,5 t$:	1,24 1,39 1,57
34		The strengthenings fillet welded to the plate: – where weld edges are ground: – welds without treatment: Note: for larger openings, direct calculation of geometric stresses is recommended.	1,10 1,24

⁽¹⁾ DT – non-destructive tests of the whole weld.

2.2.9 Resultant Stress Range Calculation

2.2.9.1 General

The present paragraph specifies the method of determining the resultant stress ranges in hull longitudinal members subject to superposition of instantaneous values of global stresses, i.e. the stresses generated by horizontal and vertical hull bending and cross-section warping at torsion, as well as local stresses – induced by the bending of plating, the plating stiffeners and girders due to sea water, ballast water or liquid cargo pressures, cargo inertia forces, etc.

The method of determining the resultant range of pressures generated by dynamic external and internal pressures acting simultaneously on the ship's hull is also given.

The values of the resultant stress and pressure ranges are exceeded with a probability level of 10^{-4} .

The value of the resultant stress range is obtained directly from the long-term stress range distribution (para. 2.3) and is used directly in the calculation of the structural member fatigue strength – in accordance with 2.6.

2.2.9.2 Resultant Pressures Range

Where the resultant local stresses range due to simultaneous action of external and internal pressures (para. 2.2.6.5) is calculated directly, the resultant pressure range is to be determined from the formula:

$$\Delta p_R = \text{Max} (\Delta p_z, \Delta p_w) + 0,4 \text{ Min} (\Delta p_z, \Delta p_w), [\text{kPa}] \quad (2.2.9.2)$$

where:

Δp_z – the external pressures range, calculated according to 2.2.4.2 or 2.2.4.3, [kPa];

Δp_w – the internal pressures range, calculated according to 2.2.4.4 or 2.2.4.5, [kPa].

It is important to note that the values Δp_z and Δp_w are to be taken as nonnegative (the absolute values).

2.2.9.3 Resultant Global Stresses Range

The resultant global stresses range $\Delta\sigma_g$, due to simultaneous hull vertical and horizontal bending is to be calculated from the formula:

$$\Delta\sigma_g = \text{Max} (C\Delta\sigma_v, C\Delta\sigma_H) + 0,3 \text{ Min} (C\Delta\sigma_v, C\Delta\sigma_H), [\text{MPa}] \quad (2.2.9.3)$$

where:

C – stress concentration factor determined in accordance with 2.2.8.3 and 2.2.8.4. Where the fatigue strength calculations are made directly on the basis of nominal stress ranges and appropriately selected S-N curve (2.4), $C=1.0$ is to be taken;

$\Delta\sigma_v, \Delta\sigma_H$ – stress ranges due to vertical and horizontal hull bending, calculated according to 2.2.2 and 2.2.3, [MPa].

Where, in the hull fatigue strength analysis, account is also taken of hull torsion, the $\Delta\sigma_H$, given above, denotes the stress range due to simultaneous hull horizontal bending and cross-section warping at torsion. When calculating $\Delta\sigma_H$, the stresses due to torsion and bending, exceeded with a probability level of 10^{-4} (calculated in accordance with PRS Publication No. 24/P “Strength Analysis of Container Ship Hull Structure”), are to be algebraically summed up. The obtained result is to be multiplied by $2(0.5)^{1/\xi}$ (ξ – Weibull distribution factor, calculated in accordance with 2.2.3).

The value of $\Delta\sigma_g$ is applied to determining the resultant stress range $\Delta\sigma_r$ – according to 2.2.9.5.

2.2.9.4 Resultant Local Stresses Range

The present paragraph specifies the method of determining the resultant local stresses range $\Delta\sigma_l$ where the stress ranges due to dynamic external pressures (sea pressures) and dynamic internal pressures (water ballast, liquid cargo, bulk cargo pressures, reaction forces from unit cargo, etc.) are calculated separately – in accordance with the requirements of 2.2.4.

$\Delta\sigma_l$ is to be calculated from the formula:

$$\Delta\sigma_l = \text{Max} (C\Delta\sigma_z, C\Delta\sigma_w) + 0,4 \text{ Min} (C\Delta\sigma_z, C\Delta\sigma_w), [\text{kPa}] \quad (2.2.9.4)$$

where:

C – stress concentration factor (as given in 2.2.9.3);

$\Delta\sigma_z$ – stress range due to external pressures, specified in accordance with the requirements of 2.2.5 ÷ 2.2.7, [MPa];

$\Delta\sigma_w$ – stress range due to internal pressures, calculated as above, [MPa].

$\Delta\sigma_z$ or $\Delta\sigma_w$ may be obtained as a sum of several types of stresses – e.g. in longitudinal stiffener located in longitudinal girder effective strip of plating, the stress ranges will be obtained from algebraic superposition of normal stresses induced by local bending of stiffener (supported by transverse girders) and girder bending.

In some cases, one of the components of $\Delta\sigma_z, \Delta\sigma_w$ (or even both) may take the zero value. The values of $\Delta\sigma_z$ and $\Delta\sigma_w$, used in formula 2.2.9.4, are to be always taken as nonnegative values (the absolute values).

In the case of hull transverse members, the value of $\Delta\sigma_l$ may be directly used in the calculation of structural member fatigue strength – according to 2.6.

In the case of longitudinal members – the fatigue strength is to be calculated using the resultant stress range $\Delta\sigma_r$, calculated taking into account $\Delta\sigma_l$, – in accordance with 2.2.9.5.

2.2.9.5 Resultant Stress Range

The resultant stress range $\Delta\sigma_r$ in hull longitudinal members used directly in the calculation of structural members fatigue strength, in accordance with 2.6, is to be determined based on the values of $\Delta\sigma_g$ (2.2.9.3) and $\Delta\sigma_l$ (2.2.9.4) according to the formula:

$$\Delta\sigma_r = \text{Max} (\Delta\sigma_g, \Delta\sigma_l) + K_{gl} \text{ Min} (\Delta\sigma_g, \Delta\sigma_l), [\text{MPa}] \quad (2.2.9.5-1)$$

K_{gl} denotes load combination factor (dimensionless). The value of the factor is to be determined as follows:

– for structural members at base plane level:

$$K_{gl} = 0,7 \quad (2.2.9.5-2)$$

– for structural members located above the waterline under consideration:

$$K_{gl} = 0,6 \quad (2.2.9.5-3)$$

– for structural members located between the base plane and the level of the waterline under consideration (draught T_1 , [m]):

$$K_{gl} = 0,7 - 0,1 \frac{z}{T_1} \quad (2.2.9.5-4)$$

z – distance from the structural member to the base plane, [m].

2.3 Long-Term Stress Range Distribution

2.3.1 General

Long-term distribution of resultant stress range (as well as particular components) is approximated by Weibull distribution in the form of formulae 2.3.2-1 and 2.3.2-2.

Formula 2.3.2-2 is then directly used in the fatigue life calculation according to the requirements of 2.6.

2.3.2 Weibull Distribution

Probability that, during the ship design life, the stress range $\Delta\sigma$ will be not smaller than the assumed value of $\Delta\sigma_0$ is determined by the formula:

$$\Pr(\Delta\sigma \geq \Delta\sigma_0) = e^{-\left(\frac{\Delta\sigma_0}{a}\right)^\xi} \quad (2.3.2-1)$$

where:

ξ – numerical factor determined according to 2.3.3;

$$a = \frac{\Delta\sigma_R}{\left(\ln N_R\right)^{\frac{1}{\xi}}};$$

$\Delta\sigma_R$ – The value of stress range exceeded with a probability level of $\frac{1}{N_R}$.

Note: In the present Publication, $\frac{1}{N_R} = 10^{-4}$, i.e. $N_R = 10000$ has been taken.

Probability density $p(\Delta\sigma_0)$ corresponding to formula 2.3.2-1 is determined by the formula:

$$p(\Delta\sigma_0) = \frac{\xi}{a} \left(\frac{\Delta\sigma_0}{a}\right)^{\xi-1} e^{-\left(\frac{\Delta\sigma_0}{a}\right)^\xi} \quad (2.3.2-2)$$

2.3.3 Coefficient ξ Values

In the midship portion of the hull, the values of ξ for determining stress distribution $\Delta\sigma$ of particular components of stress ranges and the resultant stress range are to be taken as follows:

bulk carriers and tankers:

$$\xi = 1,0 \text{ when } L_0 = 150 \text{ m}; \quad (2.3.3-1)$$

$$\xi = 0,9 \text{ when } L_0 = 350 \text{ m};$$

intermediate values of length L_0 are to be determined by linear interpolation:

container ships:

$$\xi = 1,10 \text{ when } L_0 = 150 \text{ m}; \quad (2.3.3-2)$$

$$\xi = 0,95 \text{ when } L_0 = 250 \text{ m};$$

intermediate values of length L_0 are to be determined by linear interpolation.

For midship portion of other ship types and portion beyond midship for all ship types, the following values of ξ are to be taken:

$$\xi = 1,1 - 0,35 \frac{L_0 - 100}{300} \quad (2.3.3-3)$$

2.4 Welded Joints Classification. S-N Curves

2.4.1 General

In 2.4.2, the correlation between typical welded joints and basic DEN S-N curves, is given.

When calculating fatigue strength in accordance with the requirements of 2.6 using nominal stress ranges, the following is to be performed:

- the welded joint under consideration is to be qualified into one of the variants indicated in Table 2.4.2;
- S-N curve parameters resulting from the joint classification (Table 2.4.2) are to be established according to 2.4.3;
- S-N curve parameters are to be modified in accordance with the requirements of 2.5;
- the joint fatigue life is to be calculated in accordance with 2.6.

Where in the fatigue life calculations, the values of stress concentration factors given in 2.2.8 or hot-spot stress ranges obtained directly from FEM analysis (4.2) are used, then in the calculations according to 2.6 “D” curve (see 2.4.3), modified (where necessary) according to 2.5, is to be used.

2.4.2 Welded Joints Classification

In Table 2.4.2, configuration of typical welded joints, the reference S-N curve type, description of the welded joints and additional information are given. Areas of potential cracks are indicated (in the drawings and description). Nominal stresses to be used in association with S-N curves are also presented.

Table 2.4.2
Typical welded joints classification

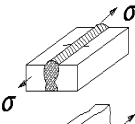
Item.	Joint configuration	S-N curve	Description of joint and explanatory note on fatigue crack mode	Additional information
I. Parent metal – see Note 1) to the Table				
1a		B	Parent material in the as rolled condition with no flame-cut edges.	Where corrosion pits on material surface are likely to occur, S-N curve, type C is to be used.
1b		B	As 1a, but with flame-cut edges, subsequently ground.	Any re-entrant corners in flame-cut edges are to be rounded with a radius not smaller than the material thickness.
1c		C	As 1a, but with the edges machine flame-cut by a controlled procedure to ensure that the cut surface is free from cracks.	Where re-entrant corners occur, the nominal stress range is to be multiplied by the relevant stress concentration factor.
II. Continuous butt welds or fillet welds, parallel to the direction of stresses – see Note 2) to the Table				
2a		B	Full penetration butt welds, weld reinforcements ground flush with the surface in the direction of stress. Quality of weld checked by NDT	The size of permissible weld defects is to be determined by fracture mechanics methods. The NDT technique must be selected with a view to ensuring the detection of such significant defects.
2b		C	Butt or fillet welds made together with start-on plates.	If during welding, an accidental stop-start occurs, remedial action is to be taken so that the finished weld has a similar surface and root profile to that intended.
2c		D	As 2b), but with the weld made with stop-start positions within the length.	For the ends of doubling plates on flanges, variant 12 is required.

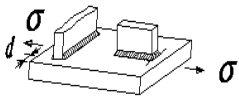
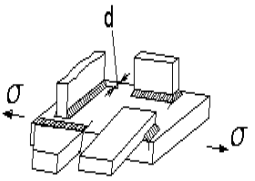
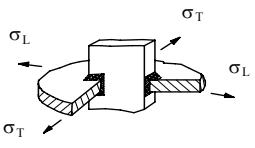
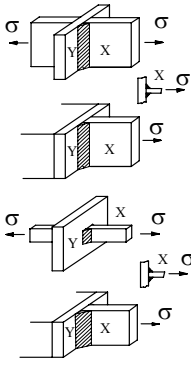
Item.	Joint configuration	S-N curve	Description of joint and explanatory note on fatigue crack mode	Additional information
III. Welded attachments on the surface or edge of stressed member (plate) – see Note 3) to the Table				
3			Fatigue cracks of the loaded plate parent metal, in the vicinity of weld, regardless of the weld location with respect to the direction of stresses and the type of weld (continuous or intermittent).	The shape of full penetration or partial joint external weld is to be similar to fillet weld.
3a		F	The welded attachment length parallel to the direction of the stresses not greater than 150 mm; the edge distance not greater than 10 mm.	
3b		F2	The welded attachment length parallel to the direction of the stresses not greater than 150 mm; the edge distance greater than 10 mm.	
4			Fatigue cracks of the stressed plate parent metal in the vicinity of edges or weld ends situated at the distance of ≤ 10 mm from the plate edge, irrespective of the welded attachment shape.	G-curve is used, irrespective of the welded attachment dimensions.
5			Fatigue cracks of the stressed plate parent metal in way of full penetration welded joint connecting the stressed plate with the penetrating element.	The classification does not apply to fillet welded joints. It does not depend on loading in either direction ("L" or "T").
5a			F	The dimensions of the penetrating element (in the direction of stresses in the plate) ≤ 150 mm and the edge distance > 10 mm.
5b		F2	The dimensions of the penetrating element (in the direction of stresses in the plate) > 150 mm and the edge distance > 10 mm.	
5c		G	The edge distance ≤ 10 mm.	
IV. Fillet and butt welds carrying loads perpendicular to the direction of welds – see Note 4) to the Table				
6			F	Fatigue cracks of parent metal in the vicinity of cruciform or tee joints (element X in the drawings).
6a		F	Full penetration butt welds. Any undercutting at the corners of the member dressed out by local grinding.	The edge distance requirement the same as that given in 3a) and 3b). Failure is likely to occur in the weld throat unless the weld is sufficiently large.
6b		F2	Partial penetration butt welds or fillet welds. Any undercutting at the corners of the member dressed out by local grinding.	

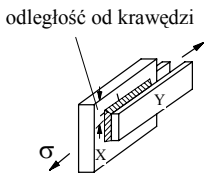
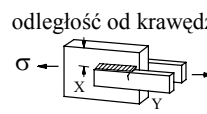
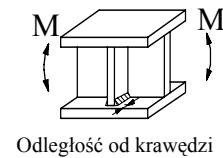
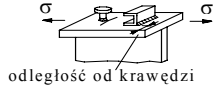
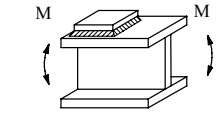
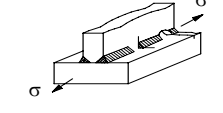
Item.	Joint configuration	S-N curve	Description of joint and explanatory note on fatigue crack mode	Additional information
7			Parent metal adjacent to the toe of load-carrying fillet welds which are transverse to the direction of applied stress (member in X in the drawings).	Stresses in member X are to be calculated for rectangular cross-section with dimensions: X member thickness and Y member width.
7a		F2	Edge distance ≥ 10 mm.	F2-curve is to be also applied to welded joints, which are parallel to the direction of stresses.
7b		G	Edge distance ≥ 10 mm.	
8		G	Parent metal at the ends of load-carrying fillet welds, which are parallel to the direction of applied stresses (member Y in the drawing).	
9		W	Weld metal in the load-carrying joints (fillet or partial penetration welds). The welds either transverse or parallel to the direction of applied stress. Note: Fatigue strength is to be calculated for $\Delta\sigma$ equal to nominal shear stresses determined for minimum weld throat area.	
V. Details (elements in welded girders) and stiffeners – see Note 5) below the Table				
10			Parent metal at the toe of a weld connecting an element with girder/stiffener flange.	
10a		F	Edge distance ≥ 10 mm.	
10b		G	Edge distance ≥ 10 mm.	
11			Girder/stiffener parent metal at the toe of a weld.	
11a 11b		F G	Edge distance ≥ 10 mm. Edge distance ≥ 10 mm.	
12		G	Parent metal adjacent to the ends of discontinuous welds.	G-curve is to be also applied to doubling plates that are wider than a flange.
13a 13b		E	Parent metal adjacent to the ends of discontinuous welds, e.g. intermittent web/flange, tack welds.	
		F	Where cut-outs in web have been applied. Stress concentration in the cut-out area.	Stress concentration due to cut-outs is to be disregarded.

Notes to Table 2.4.2:

- 1) In parent metal, fatigue cracks initiate at the surface – usually at surface irregularities or at corners of beam cross-section. In welded structure, fatigue cracks occur in areas adjacent to welds or in the welds. S-N curve recommended for 1a, 1b and 1c joint types are to be also applied to curved elements (without welds) – e.g. cargo hatch corners. In such case $\Delta\sigma$ is to be determined as the principal stress range, parallel to the member edge (see also item 4.2).
- 2) Where the weld reinforcements are ground flush, fatigue cracks would be expected to initiate at weld defect locations. In as-welded condition, fatigue cracks might initiate at stop-start positions or at weld surface ripples. If backing strips are used in the welding process, the following is to be done:
 - a) the strips should be continuous,
 - b) the strips fatigue strength should be assessed.An edge distance criterion is applied to limit the possibility of local stress concentration occurring on unwelded edges as a result, e.g. of undercut, weld spatter or accidental over weave in manual fillet welding.
- 3) When the weld is parallel to the direction of applied stress, fatigue cracks initiate at the weld ends. When the weld is transverse to the direction of the applied stress, the fatigue cracks initiate at the weld toe or at the weld root.

Where the welds are on or adjacent to the edge of the stressed member, the stress concentration is increased and the fatigue strength is reduced. Therefore, joint classification is based on edge distance.
- 4) Fatigue cracks in full penetration cruciform or tee joints will normally initiate at the weld toe. In fillet welds or partial penetration butt welds, fatigue cracks may initiate at the weld toe and propagate into the plate or at the weld root and propagate through the weld.

In welds parallel to the direction of the applied stress, fatigue cracks seldom occur. The cracks usually initiate at the weld and propagate into plate perpendicular to the direction of applied stress.

Where the weld end is located on or adjacent to the edge of the stressed member, the stress concentration is increased and the fatigue strength is reduced.
- 5) Fatigue cracks generally initiate at the weld toes and are especially located with local stress concentration at weld ends, short lengths of return welds and changes of direction. Stress concentration is increased when these features occur at or near an edge of the plate. Most of type V joints are shown in type III joints. They are included here to show the application of types III joints to typical notches of stiffeners and girders.

2.4.3 S-N Curves

S-N curves can be expressed as:

$$N = \frac{K}{(\Delta\sigma)^m} \quad (2.4.3)$$

N – number of cycles at which damage to the structural member occurs (collapse or fracture) at the constant value of stress range $\Delta\sigma$, [MPa];

K, m –parameters depending on S-N curve type, given in Table 2.4.3-1.

Note: K, m parameters do not depend on steel yield stress.

S-N curves (in the form of diagram) are shown in Fig. 2.4.3.

S-N curves in the form of formula 2.4.3 are generally subject to modification in accordance with the requirements of 2.5.

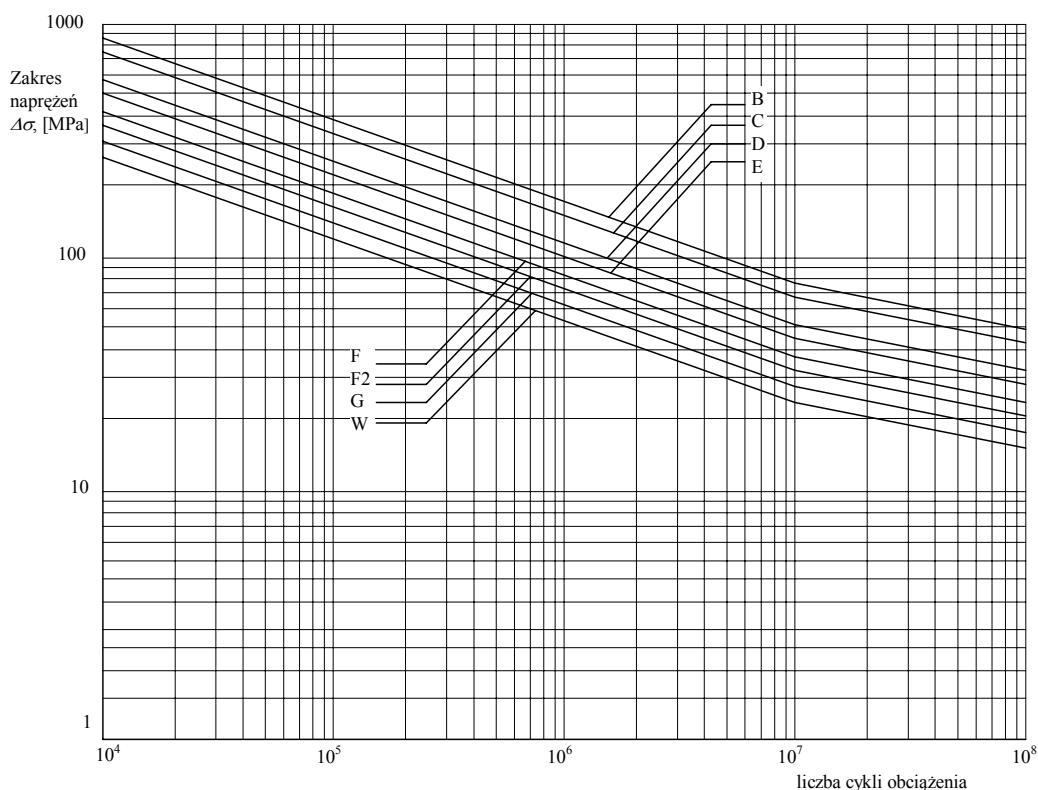

Fig. 2.4.3 S-N curve (s)

Table 2.4.3-1
K and m parameters of S-N curves

Type of curve	$N \leq 10^7$		$N > 10^7$	
	m	K	M	K
B	3	$5.800 \cdot 10^{12}$	5	$4.034 \cdot 10^{16}$
C	3	$3.464 \cdot 10^{12}$	5	$1.708 \cdot 10^{16}$
D	3	$1.520 \cdot 10^{12}$	5	$4.329 \cdot 10^{15}$
E	3	$1.026 \cdot 10^{12}$	5	$2.249 \cdot 10^{15}$
F	3	$6.319 \cdot 10^{11}$	5	$1.002 \cdot 10^{15}$
F2	3	$4.330 \cdot 10^{11}$	5	$5.339 \cdot 10^{14}$
G	3	$2.481 \cdot 10^{11}$	5	$2.110 \cdot 10^{14}$
W	3	$9.279 \cdot 10^{10}$	5	$4.097 \cdot 10^{13}$

Instead of carrying out fatigue strength calculations for K , m parameters of the given S-N curve, we can use K and m parameters for “D” curve and additionally apply the modified value of $\Delta\sigma$ obtained by multiplying the nominal stress range by reduction factor taken according to Table 2.4.3-2.

Table 2.4.3-2
S-N curves reduction factors

Type of curve	B	C	D	E	F	F2	G	W
Reduction factor	0.64	0.76	1	1.14	1.34	1.52	1.83	2.13

2.4.4 Prototype Fatigue Tests

2.4.4.1 In the case of prototype structures featuring non-typical structural details, the fatigue strength assessment using laboratory fatigue tests may be required.

The fatigue tests may be performed for constant amplitude loadings, taking the following precautions:

- the steel used for the test model is to be of the same grade as that provided for the actual structure;

- welding procedures are to be the same as those applied at the actual structure construction;
- the stress ratio $R = \frac{\sigma_{\min}}{\sigma_{\max}}$ is to remain constant during the experiments; it is recommended that R be taken between 0 and 0.1.

2.4.4.2 Detailed requirements relating to fatigue tests are specified by PRS in each particular case.

2.4.4.3 In addition to the fatigue tests, it is recommended that 3D FEM structural analyses should be performed for the test model to validate the calculation procedure for determination of hot spot stresses in the actual structure.

It is recommended, in particular, that theoretical stresses should be calculated at locations where stress measurements are carried out during the fatigue testing.

2.5 Modification of S-N Curves

2.5.1 General

S-N curves selected for fatigue strength calculations according to the requirements of 2.4 are to be modified for compression stresses in load cycle (2.5.2), the member thickness (2.5.3) and the corrosion environment or cargo effect (2.5.4).

It may be also required that assembling tolerances should be taken into account – according to the requirements of 2.5.5.

2.5.2 Compression Stresses Effect

Where in a single load cycle (Fig. 2.1.1) $\sigma_{\min} < 0$, then to calculate the fatigue strength, the corrected stress range $\Delta\sigma = \Delta\sigma_1$, calculated from the below formula, is used:

$$\Delta\sigma_1 = \sigma_t + 0,6 \sigma_c \quad (2.5.2)$$

where:

$$\sigma_t = \text{Max}(\sigma_{\max}, 0);$$

$$\sigma_c = \sigma = \text{Min}(|\sigma_{\max} - \sigma_{\min}|, |\sigma_{\min}|).$$

In such case, the fatigue strength parameter is to be calculated according to formula 2.6.5-1.

If $\Delta\sigma_{\min} \geq 0$, then $\Delta\sigma$ is to be taken according to the definition given in 2.1.1.

2.5.3 Member Thickness Effect

Where the plate thickness in welded joint exceeds the value $t_B = 25$ mm and the fatigue strength is checked, and where the anticipated fracture propagates into the plate, then the stress range, calculated according to 2.5.2, is to be additionally corrected using the value $\Delta\sigma = \Delta\sigma_2$:

$$\Delta\sigma_2 = \frac{\Delta\sigma_1}{\left(\frac{t_B}{t}\right)^{0.3}} \quad (2.5.3)$$

For $t \leq t_B$, correction according the above formula is not to be made.

2.5.4 Corrosive Environment or Cargo Effect

For structural members effectively protected against corrosion (cathodic protection system or paint coating applied), the fatigue strength is to be calculated using S-N curves with parameters according to Table 2.4.3-1.

For structural members not provided with corrosion protection system or where the paint coating is no longer effective (relatively long time has elapsed from the paint coating application), parameters given in Table 2.4.3-1 are to be modified as follows:

- the value of K for $N \leq 10^7$ is to be divided by 2;
- for $N \geq 10^7$, the value of K , as above, is to be applied and $m = 3$ is to be used instead $m = 5$.

2.5.5 Assembling Accuracy

In the case where the assembling accuracy does not satisfy the acceptable shipbuilding standards, the reduction of the structural members fatigue strength is to be taken into account by using, in the calculations, the additional values of stress concentration factors (see 2.2.8).

In the case of misalignment e between two abutting members, the value of additional stress concentration factor used for axial stresses in plates is equal to:

$$C_e = 1 + \frac{3e}{t} \quad (2.5.5)$$

2.6 Calculation of Fatigue Strength

2.6.1 General

The standard of hull structural members fatigue strength, applied in the present *Publication*, is based on the assumption that the ship can be operated for at least 20 years in the North Atlantic Ocean.

If it is predicted by the Owner that the ship will be operated on a route with less adverse (statistically taken) sea and weather conditions, it is permitted that the calculations of structural members fatigue strength be made for long-term stress distribution, calculated directly for the predicted route – in accordance with Chapter 3.

In such case, subject to a separate consideration, PRS may also give consent to performance of simplified calculations using long-term stress distribution, determined according to 2.3 for $\Delta\sigma_R$ reduced by 20 % ($\Delta\sigma_R$ is determined for design loads taken according to the Rules).

The fatigue strength criterion may be approximately verified according to 2.6.8.

2.6.2 Loading Conditions

When calculating fatigue strength, account is to be taken of loading conditions representative of the given ship and specified in stability booklet.

It is permitted that the fatigue strength calculations be made considering only the following two loading conditions:

- ship in fully loaded condition,
- ship in ballast condition.

The relative ship service life for these loading conditions, to be used in the fatigue strength calculations of most popular ship types, is given in Table 2.6.2.

Table 2.6.2
Relative ship service life coefficients for fully loaded and ballast conditions

Ship type	α	β
	Fully loaded condition	Ballast condition
Tankers, gas tankers	0,5	0.5
Bulk carriers	0,6	0.4
General cargo ships, container ships	0,75	0.25

2.6.3 Period of Exposure to Corrosive Environment Effect

For structural members situated in ballast water and cargo tanks in oil tankers and in cargo holds of bulk carriers, in which cathodic protection against corrosion has not been applied, it is to be assumed that during the first half of the ship operation period the applied paint coating is effective. In the fatigue strength calculations, S-N curves with parameters as given in 2.4.3 are to be used.

For the remaining ship operation period, the modified S-N curves with parameters determined according to 2.5.4 are to be used.

2.6.4 Structural Members Scantlings Used in Calculations

The ranges of global stresses, i.e. the stresses generated by hull vertical and horizontal bending and possibly torsion (see 2.2.2 and 2.2.3) are to be calculated for structural member thickness design scantlings, i.e. without deduction of corrosion additions.

Where PRS Rules, Part II – Hull require the application of corrosion additions (i.e. in tanks or bulk carriers cargo holds) and the hull structural members are not effectively protected against corrosion, the local stress ranges due to bending of plating, stiffeners and girders (see 2.2.5 ÷ 2.2.7) for the second half of the assumed ship service life are to be calculated using the structural member thickness net scantlings, i.e. after deduction of corrosion additions.

In the remaining cases, the values of local stress ranges may be calculated for structural member thickness design scantlings.

2.6.5 Fatigue Strength Criterion

When checking the fatigue strength of hull structural members, the cumulative damage is to be determined from formula 2.6.5-1 assuming that the ship operates in the same loading condition during its whole service life (in majority of cases – 20 years):

$$D_0 = \sum_{i=1}^{I_p} \frac{n_i}{N_i} \quad (2.6.5-1)$$

I_p – number of sub-ranges into which the stress range $< 0, 2R_e >$ has been divided.
 I_p is not to be smaller than 50.

$n_i = p(\Delta\sigma_i) \Delta\sigma_i N_L$;

$\Delta\sigma_i = \frac{2R_e}{I_p}$;

$\Delta\sigma_i = (i - 0.5) \Delta\sigma_i$;

$p(\Delta\sigma_i)$ – the value of the probability density function, calculated according to formula 2.3.2-2 substituting $\Delta\sigma_o = \Delta\sigma_i$, or calculated directly in accordance with Chapter 3 ($\Delta\sigma_i$ denotes the value of stress range before modification according to 2.5);

N_L – number of load cycles during ship operation period, taken according to 2.6.6;

N_i – number of load cycles calculated for $\Delta\sigma = \Delta\sigma'_i$ according to S-N curve equation (2.4.3). $\Delta\sigma'_i$ denotes the corrected value of stress range according to the requirements of 2.5.

Note: It is allowed to make calculations according to formula 2.6.5-1 assuming different lengths of particular sub-ranges. In such case, the accuracy of calculations is to be not worse than that obtained using algorithm, described above.

Where structural members are effectively protected against corrosion during the whole ship operation life, the following condition is to be satisfied:

$$D = \alpha D_0 + \beta D'_0 \leq 1 \quad (2.6.5-2)$$

α, β – coefficients taken according to Table 2.6.2 or based on reliable statistical data;

D_0 – the magnitude calculated according to formula 2.6.5-1 for stress ranges determined for fully loaded condition;

D'_0 – as above, for ballast condition.

Where structural members are not effectively protected against corrosion, the following condition is to be satisfied:

$$\frac{1}{2}(D' + D'_k) \leq 1 \quad (2.6.5-3)$$

D' – the value of D calculated according to formula 2.6.5-2 for the basic S-N curve selected according to 2.4 and the structural member thickness design scantlings;

D'_k – the value of D calculated according to formula 2.6.5-2 for S-N curve corrected according to 2.5.4 and the structural member scantlings determined according to 2.6.4 – for the final years of ship operation.

Fatigue life L_f of the hull structural member, measured in years, may be calculated from the formula:

$$L_f = \frac{L_e}{D} \quad (2.6.5-4)$$

L_e – the assumed ship service life (not less than 20 years) for which D has been calculated;
 D – cumulative damage, calculated according to formula 2.6.5-2.

2.6.6 Number of load cycles in the ship's operational life

The number of load cycles N_L during 20 years of ship operation, assuming that 85% of this period is spent at sea, is:

$$N_L = \left(5 + \frac{150 - L_0}{200}\right) \cdot 10^7 \quad (2.6.6)$$

L_0 – ship design length, [m].

For other value of the assumed ship operational life, the value of N_L is to be taken in direct proportion to that determined according to formula 2.6.6, i.e. for the period of 20 years.

2.6.7 Formula for Cumulative Damage Calculation

If the values of the resultant stress ranges are corrected for compression stress (according to 2.5.2) or the long-term stress range distribution is calculated according to Chapter 3, then D_0 is to be calculated according to formula 2.6.5-1.

In other cases, D_0 may be calculated directly according to the following formulae:

$$D_0 = \frac{N_L}{K} \frac{(\Delta\sigma_R)^m}{(\ln N_R)^{m/\xi}} \mu \Gamma\left(1 + \frac{m}{\xi}\right) \quad (2.6.7-1)$$

where:

$$\mu = 1 - \left\{ \gamma\left(1 + \frac{m}{\xi}, \nu\right) - \nu^{-\frac{\Delta m}{\xi}} \gamma\left(1 + \frac{m + \Delta m}{\xi}, \nu\right) \right\} / \Gamma\left(1 + \frac{m}{\xi}\right)$$

N_L – number of load cycles, calculated according to 2.6.6;

$m = 3,0$ – S-N curve parameter (2.4.3);

K – S-N curve parameter for $N \leq 10^7$, given in Table 2.4.3-1;

$\Delta\sigma_R$ – the resultant stress range (corrected according to 2.5.3 for the structural member thickness, where necessary), exceeded with a probability level of $\frac{1}{N_R} = 10^{-4}$ ($N_R = 10^4$);

ξ – the value of Weibull distribution factor (2.3.2 and 2.3.3);

Γ – Gamma function, as given in Table 2.6.7-1;

$$\nu = \left(\frac{\Delta\sigma_q}{\Delta\sigma_R}\right)^\xi \ln N_R;$$

$\Delta\sigma_q$ – the value of stress range, calculated according to S-N curve equation (2.4.3) for $N = N_q = 10^7$;

$\Delta m = 2$ – where S-N curve is not modified for the corrosive effect of sea water or cargo (para. 2.5.4);

$\Delta m = 0$ – where S-N curve is modified for the corrosive effect of sea water or cargo;

γ – incomplete Gamma function, as given in Table 2.6.7-2.

If $\Delta m = 0$, then D_0 may be calculated from the formula:

$$D_0 = \frac{N_L}{K} \frac{(\Delta\sigma_R)^m}{(\ln N_R)^{m/\xi}} \Gamma\left(1 + \frac{m}{\xi}\right) \quad (2.6.7-2)$$

Definition of symbols as in formula 2.6.7-1.

Table 2.6.7-1
Gamma function (Γ)

N	$\Gamma(n+1)$	$\log\Gamma(n+1)$	N	$\Gamma(n+1)$	$\log\Gamma(n+1)$
0,10	0,9514	-0,02166	5,10	142,5	2,154
0,20	0,9187	-0,03708	5,20	169,4	2,229
0,30	0,8975	-0,04698	5,30	201,8	2,305
0,40	0,8873	-0,05195	5,40	240,8	2,382
0,50	0,8862	-0,05246	5,50	287,9	2,459
0,60	0,8935	-0,04890	5,60	344,7	2,537
0,70	0,9086	-0,04161	5,70	413,4	2,616
0,80	0,9314	-0,03087	5,80	496,6	2,696
0,90	0,9618	-0,01693	5,90	597,5	2,776
1,00	0,9999	0,00000	6,00	719,9	2,857
1,10	1,0465	0,01973	6,10	869,0	2,939
1,20	1,1018	0,04210	6,20	1050,3	3,021
1,30	1,1667	0,06696	6,30	1271,4	3,104
1,40	1,2422	0,09418	6,40	1541,3	3,188
1,50	1,3293	0,12364	6,50	1871,3	3,272
1,60	1,4296	0,15522	6,60	2275,0	3,357
1,70	1,5447	0,18884	6,70	2769,8	3,442
1,80	1,6765	0,22440	6,80	3376,9	3,529
1,90	1,8274	0,26182	6,90	4122,7	3,615
2,00	1,9999	0,30103	7,00	5039,9	3,702
2,10	2,1976	0,34195	7,10	6169,6	3,790
2,20	2,4240	0,38453	7,20	7562,3	3,879
2,30	2,6834	0,42869	7,30	9281,4	3,968
2,40	2,9812	0,47439	7,40	11405,9	4,057
2,50	3,3234	0,52158	7,50	14034,4	4,147
2,60	3,7170	0,57020	7,60	17290,2	4,238
2,70	4,1707	0,62020	7,70	21337,7	4,329
2,80	4,6944	0,67156	7,80	26334,0	4,421
2,90	5,2993	0,72422	7,90	32569,4	4,513
3,00	5,9999	0,77815	8,00	40319,9	4,606
3,10	6,813	0,8333	8,10	49974	4,699
3,20	7,757	0,8897	8,20	63011	4,792
3,30	8,855	0,9472	8,30	77036	4,887
3,40	10,136	1,0059	8,40	95809	4,981
3,50	11,632	1,0656	8,50	119292	5,077
3,60	13,381	1,1265	8,60	148696	5,172
3,70	15,431	1,1884	8,70	185550	5,268
3,80	17,838	1,2513	8,80	231792	5,365
3,90	20,667	1,3153	8,90	289868	5,462
4,00	23,999	1,3802	9,00	362880	5,560
4,10	27,932	1,4461	9,10	454761	5,658
4,20	32,578	1,5129	9,20	570499	5,756
4,30	38,078	1,5807	9,30	716431	5,855
4,40	44,599	1,6493	9,40	900609	5,955
4,50	53,343	1,7189	9,50	1133278	6,054
4,60	61,554	1,7893	9,60	1427482	6,155
4,70	72,528	1,8605	9,70	1799844	6,255
4,80	85,622	1,9326	9,80	2271560	6,356
4,90	101,270	2,0054	9,90	2869690	6,458
5,00	119,999	2,0792	10,00	3628799	6,560

Table 2.6.7-2
Incomplete Gamma function (γ)

x	$\gamma(x+1,3)$	$\gamma(x+1,4)$	$\gamma(x+1,5)$	$\gamma(x+1,6)$
0,0	0,0498	0,01832	0,00674	0,00248
0,1	0,0571	0,02148	0,00805	0,00301
0,2	0,0654	0,02520	0,00962	0,00365
0,3	0,0750	0,02958	0,01150	0,00444
0,4	0,0861	0,03472	0,01376	0,00539
0,5	0,0989	0,04078	0,01645	0,00654
0,6	0,1136	0,04790	0,01968	0,00795
0,7	0,1306	0,05630	0,02356	0,00966
0,8	0,1503	0,06618	0,02820	0,01174
0,9	0,1729	0,07784	0,03376	0,01427
1,0	0,1991	0,09158	0,04043	0,01735
1,1	0,2295	0,1078	0,04843	0,02110
1,2	0,2646	0,1269	0,05803	0,02567
1,3	0,3052	0,1495	0,06956	0,03122
1,4	0,3524	0,1762	0,08339	0,03799
1,5	0,4071	0,2077	0,10001	0,04624
1,6	0,4706	0,2450	0,11998	0,05630
1,7	0,5444	0,2890	0,14398	0,06855
1,8	0,6302	0,3412	0,17284	0,08349
1,9	0,7300	0,4030	0,20755	0,10171
2,0	0,8464	0,4762	0,24930	0,12394
2,1	0,9820	0,5630	0,29956	0,15106
2,2	1,1402	0,6659	0,36008	0,18416
2,3	1,3251	0,7880	0,43298	0,22457
2,4	1,5411	0,9330	0,52081	0,27391
2,5	1,7938	1,105	0,62670	0,33419
2,6	2,0897	1,310	0,75439	0,40785
2,7	2,4366	1,554	0,90845	0,49787
2,8	2,8436	1,844	1,094	0,60794
2,9	3,3215	2,189	1,319	0,74255
3,0	3,8834	2,601	1,590	0,90722
3,1	4,5446	3,092	1,918	1,109
3,2	5,3234	3,678	2,314	1,355
3,3	6,2417	4,377	2,794	1,658
3,4	7,3257	5,213	3,374	2,028
3,5	8,6065	6,213	4,077	2,481
3,6	10,122	7,410	4,928	3,037
3,7	11,916	8,842	5,960	3,719
3,8	14,043	10,56	7,211	4,555
3,9	16,567	12,62	8,729	5,581
4,0	19,566	15,09	10,57	6,841
4,1	23,134	18,06	12,81	8,389
4,2	27,382	21,63	15,53	10,29
4,3	32,446	25,93	18,84	12,66
4,4	38,491	31,10	22,86	15,50
4,5	45,714	37,34	27,76	19,03
4,6	54,356	44,86	33,73	23,38
4,7	64,706	53,93	41,00	28,74
4,8	77,118	64,90	49,87	35,33
4,9	92,019	78,16	60,70	43,46
5,0	109,93	94,22	73,92	53,48
5,1	131,49	113,7	90,07	65,84

x	$\gamma(x+1,3)$	$\gamma(x+1,4)$	$\gamma(x+1,5)$	$\gamma(x+1,6)$
5,2	157,46	137,24	109,81	81,09
5,3	188,79	165,85	133,97	99,91
5,4	226,63	200,6	163,5	123,2
5,5	272,38	242,9	199,8	151,9
5,6	327,78	294,3	244,2	187,4
5,7	394,93	356,9	298,7	231,4
5,8	476,42	433,3	365,6	285,6
5,9	575,43	526,5	447,7	353,1
6,0	695,87	640,3	548,8	436,5
6,1	842,57	779,5	673,1	540,0
6,2	1021,4	949,9	826,1	668,2
6,3	1239,3	1158,6	1014,6	827,4
6,4	1506,7	1414,5	1247,1	1025,1
6,5	1833,4	1729,6	1533,9	1270,6
6,6	2233,5	2114,6	1888,2	1575,9
6,7	2724,3	2589,3	2326,0	1955,6
6,8	3327,0	3173,7	2867,4	2428,1
6,9	4068,0	3893,9	3537,6	3016,5
7,0	4980,0	4782,3	4367,8	3749,7
7,1	6103,8	5879,2	5397,1	4663,8
7,2	7490,0	7235,0	6674,1	5804,3
7,3	9202,1	8912,4	8259,8	7228,0
7,4	11319	10990	10231	9006,5
7,5	13939	13565	12682	11230
7,6	17185	16760	15733	14010
7,7	21212	20730	19534	17490
7,8	26213	25665	24273	21848
7,9	32430	31807	30188	27311
8,0	40167	39459	37575	34161
8,1	49805	49000	46808	42757
8,2	61825	60911	58359	53553
8,3	76832	75792	72822	67119
8,4	95585	94404	90947	84179
8,5	119045	117702	113679	105648
8,6	148424	146897	142215	132685
8,7	185251	183516	178065	166755
8,8	231462	229489	223144	209722
8,9	289505	287261	279875	263946
9,0	362480	359929	351330	332426
9,1	454320	451419	441409	418972
9,2	570013	566715	555060	528430
9,3	715895	712144	698575	666967
9,4	900019	895752	879953	842437
9,5	1,133·10 ⁶	1,128·10 ⁶	1,109·10 ⁶	1,065·10 ⁶
9,6	1,427·10 ⁶	1,421·10 ⁶	1,340·10 ⁶	1,347·10 ⁶
9,7	1,799·10 ⁶	1,793·10 ⁶	1,768·10 ⁶	1,705·10 ⁶
9,8	2,270·10 ⁶	2,264·10 ⁶	2,235·10 ⁶	2,160·10 ⁶
9,9	2,869·10 ⁶	2,861·10 ⁶	2,827·10 ⁶	2,738·10 ⁶
10,0	3,628·10 ⁶	3,619·10 ⁶	3,579·10 ⁶	3,474·10 ⁶

2.6.8 Approximate Fatigue Strength Criterion Check

2.6.8.1 General

Paragraph 2.6.8 allows to effectively estimate whether the welded joint under consideration complies with the fatigue strength criteria defined in formula 2.6.5-2 or 2.6.5-3.

For this purpose, the permissible values of stress ranges used with “D” S-N curve, given in Table 2.6.8.2, as well as coefficients, given in Table 2.6.8.3 – for other S-N curves types, may be utilized.

Calculations may be carried out according to recommendations given in 2.6.8.4.

2.6.8.2 Permissible Stress Ranges for “D” S-N Curve

Table 2.6.8.2 gives the values of stress ranges $\Delta\sigma_R$ (hereinafter referred to as permissible values) used in conjunction with “D” S-N curve or a corresponding curve modified in accordance with the requirements of 2.5.4 (to account for the corrosive environment effect), for which fatigue damage $D = 1$ for the assumed number of load cycles $N_L = 4 \cdot 10^7$ or $N_L = 5 \cdot 10^7$.

The above values of N_L are typical for 20 year ship design service life.

The values of stress ranges $\Delta\sigma_R$, given in Table 2.6.8.2, are exceeded with a probability level of 10^{-4} and depend on Weibull distribution factor ξ . $\Delta\sigma_R$ and ξ explicitly determine the Weibull distribution given by formula 2.3.2-1 or 2.3.2-2.

Table 2.6.8-2
Values of stress ranges $\Delta\sigma_R$ for which $D = 1$

ξ [-]	$\Delta\sigma_R$, [MPa]			
	“D” curve		“D” curve modified for corrosion effect	
	$N_L = 4 \cdot 10^7$	$N_L = 5 \cdot 10^7$	$N_L = 4 \cdot 10^7$	$N_L = 5 \cdot 10^7$
0.85	207.1	193.6	158.3	147.0
0.86	205.0	191.6	156.5	145.3
0.87	202,8	189,6	154,8	143,7
0.88	200,7	187,6	153,1	142,1
0.89	198,7	185,7	151,4	140,6
0.90	196,7	183,9	149,8	139,0
0.91	194,7	182,1	148,2	137,6
0.92	192,7	180,3	146,6	136,2
0.93	190,8	178,5	145,1	134,7
0.94	188,0	176,8	143,6	133,3
0.95	187,2	175,1	142,1	131,9
0.96	185,4	173,5	140,7	130,6
0.97	183,7	171,9	139,3	129,3
0.98	182,0	170,3	137,9	128,0
0.99	180,3	168,8	136,6	126,8
1,00	178,7	167,3	135,3	125,6
1,01	177,1	165,8	134,0	124,4
1,02	175,5	164,4	132,7	123,2
1,03	174,0	163,0	131,5	122,0
1,04	172,5	161,6	130,2	120,9
1,05	171,0	160,2	129,1	119,8
1,06	169,5	158,9	127,9	118,7
1,07	168,1	157,6	126,8	117,7
1,08	166,7	156,3	125,7	116,6
1,09	165,2	155,0	124,6	115,6
1,10	164,0	153,8	123,5	114,6

2.6.8.3 Permissible Stress Ranges for S-N Curves other than “D” Curve

Where the fatigue strength approximate check is made on the basis of nominal stress ranges, the permissible stress ranges $\Delta\sigma_R$ may be determined by dividing the values, given in Table 2.6.8.2, by coefficients given in Table 2.6.8.3.

Table 2.6.8.3
Coefficients for determining permissible values of nominal stress ranges

S-N curve	B	C	D	E	F	F2	G	W
Coefficient	0.64	0.76	1.00	1.14	1.34	1.52	1.83	2.54

2.6.8.4 Calculation Method

Compliance with criteria defined by formula 2.6.5-2 or 2.6.5-3 may be estimated as follows:

- the approximate values of D_0 , D_0' , D_k' parameters (2.6.5) for stress ranges $\Delta\sigma$ other than those given in Table 2.6.8.2 may be calculated assuming that fatigue damage D is in direct proportion to $\Delta\sigma^3$. For the values of $\Delta\sigma = \Delta\sigma_R$, given in Table 2.6.8.2, $D = 1$;
- the values of fatigue damage D are in direct proportion to the number of load cycles N_L .

3 DIRECT CALCULATION OF FATIGUE STRENGTH

3.1 General

3.1.1 The calculation method provided in the present Chapter is recommended for the fatigue strength check of large ships constructed of higher strength steel, as well as ships of unusual dimension proportions and non-typical hull arrangement.

3.1.2 Direct calculation of hull structural members fatigue strength consist in replacing the approximate form of the long-term stress distribution, assumed as Weibull distribution (para. 2.3), by the stress distribution obtained from numerical analysis of hull loads in waves.

3.1.3 In direct calculation method, linear equations of the rigid ship motions in regular waves by using the ideal flow theory and computer programs, approved by PRS, are solved. Then, hull accelerations and sea water dynamic pressures, as well as transfer functions are calculated – with the use of FEM analysis (4.1 and 4.2) or nominal stress ranges and stress concentration factors, according to 2.2.

In the next step, short-term prediction is made using spectral analysis and Raleigh distribution approximating the probability density function (para. 3.2).

Finally, the probability density function of the long-term stress distribution and the number of load cycles in the ship's operational life (3.3), as well as the fatigue life of the considered structural member – according to the principles given in 3.4, are determined.

S-N curves are to be selected according to 2.4 and are to be corrected according to the requirements of 2.5.

3.1.4 In the calculations, account is to be taken of typical loading conditions and mean times of their occurrence. The calculations, according to 3.1.2, are to be carried out for the design ship speed. In the case of bulk carriers and tankers, only the fully loaded and ballast conditions are to be considered. It is to be assumed that 15% of the ship's operational life is spent in ports and repair shipyards, in which case the values of dynamic stresses in the structure are assumed as zero.

3.1.5 When making the fatigue strength analysis of identical hull longitudinal members, the fatigue damage in the midship section and frames sections within $0.2 L_0$ from the midship section (fore and aft) is to be calculated.

The fatigue strength assessment, addressed for the midship part of the ship, is to be based on the largest calculated value of fatigue damage D .

3.2 Short-Term Prediction of Stress Range

3.2.1 When making short-term prediction for stress ranges in hull structural members, m_0 and m_2 moments of stress range spectral density function $S_{\Delta\sigma}$, which determine the so-called Rayleigh distribution (3.2.4) or the number of load cycles (3.4), are to be calculated:

$$m_i = \int_0^{\infty} \omega^i S_{\Delta\sigma}(\omega) d\omega \quad (3.2.1)$$

$i = 0.2$ – order of density function moment;
 ω – wave frequency, [1/s];
 $S_{\Delta\sigma}(\omega)$ is to be calculated according to 3.2.2.

3.2.2 Spectral density function $S_{\Delta\sigma}(\omega)$ is to be calculated from the formula:

$$S_{\Delta\sigma}(\omega) = |Y(\omega)|^2 S_{\zeta}(\omega) \quad (3.2.2)$$

where:

ω – wave frequency, [1/s];
 $Y(\omega)$ – stress transfer function, i.e. the value of $\Delta\sigma$ corresponding to hull loads in regular waves of unit amplitude, wave frequency ω , ship speed V (see 3.1.4) and the ship course angle μ ($\mu = \pi$ when the ship moves opposite to wave direction, perpendicular to wave crest).

3.2.3 Environmental wave spectrum is to have the following form:

$$S_{\zeta}(\omega) = \frac{H_s^2}{4\pi} \left(\frac{2\pi}{T_0} \right)^4 \omega^{-5} \exp\left(- \frac{1}{\pi} \left(\frac{2\pi}{T_0} \right)^4 \omega^{-4} \right) \quad (3.2.3)$$

where:

ω – see 3.2.1;
 H_s – significant wave height, [m];
 T_0 – the average zero-up crossing wave period, [s].

3.2.4 Probability that in seaway conditions, defined by parameters H_s and T_1 (see 3.2.2) and the ship course angle μ related to wave direction, the stress range $\Delta\sigma$ will exceed the level of $\Delta\sigma_0$ is determined by Raleigh distribution:

$$\Pr(\Delta\sigma \geq \Delta\sigma_0) = \exp\left(- \frac{\Delta\sigma_0^2}{2m_0} \right) \quad (3.2.4-1)$$

where:

m_0 – zero order moment of stress range spectral density function, calculated according to formula 3.2.1-1.

The probability density function $f(\Delta\sigma)$ corresponding to formula 3.2.4-1 is obtained from the formula:

$$f(\Delta\sigma) = \frac{\Delta\sigma}{m_0} \exp\left(- \frac{1}{2} \frac{\Delta\sigma^2}{m_0} \right) \quad (3.2.4-2)$$

where:

m_0 – see 3.2.1.

3.3 Long-Term Prediction of Stress Range

3.3.1 To determine the probability density function $f_i(\Delta\sigma)$ of stress ranges during the whole ship's operational life, the long-term prediction for the values of stress range $\Delta\sigma$ is to be made.

Function $f_i(\Delta\sigma)$ may be determined from the following approximate formula:

$$f_i(\Delta\sigma) = \sum_{i=1}^{N_H} \sum_{j=1}^{N_T} \sum_{k=1}^{N_k} \sum_{l=1}^{N_l} W_{ijkl} \frac{\Delta\sigma}{m_{2ijkl}} \exp\left(- \frac{1}{2} \frac{\Delta\sigma^2}{m_{2ijkl}} \right) P_{ij} P_k P_l \quad (3.3.1-1)$$

where:

N_H – number of assumed values of significant wave height H_s ;
 N_T – number of assumed values of characteristic period T_0 ;
 N_k – number of assumed values of ship course angles related to wave direction;
 N_l – number of assumed loading conditions;
 P_{ij} – probability of occurrence of sea state defined by significant wave height H_{si} and characteristic period T_{0j} ;

- P_k – probability of occurrence of ship course angle μ_k ;
- P_l – probability of occurrence of loading condition No.1;
- m_{2ijkl} – the value of m_0 corresponding to i -th H_s value, etc. calculated according to formula 3.2.1-1;
- W_{ijkl} – coefficient taking into account different values of stress cycles numbers per second, corresponding to individual sea states, at the given ship course angle and in specified loading condition, calculated from the formula:

$$W_{ijkl} = \frac{a_{ijkl}}{a_0} \quad (3.3.1-2)$$

where:

$$a_{ijkl} = \frac{1}{2\pi} \sqrt{\frac{m_{2ijkl}}{m_{0ijkl}}}, [1/s] \quad (3.3.1-3)$$

$$a_0 = \sum_{i=1}^{N_H} \sum_{j=1}^{N_T} \sum_{k=1}^{N_K} \sum_{l=1}^{N_L} a_{ijkl} P_{ij} P_k P_l, [1/s] \quad (3.3.1-4)$$

- m_{ijkl} – the value of m_2 corresponding to i -th H_s value, calculated from formula 3.2.1-1;
- a_{ijkl} – denotes the mean value of cycles number per second.

The values of N_H , N_T and P_{ij} are to be determined according to 3.3.2, the values of N_k and P_k – according to 3.3.4 and the value of N_l – according to the requirements of 3.1.4 and 2.6.2.

3.3.2 When making calculations according to formula 3.3.1-1, it will be sufficient to use H_{si} and T_{0j} , as well as P_{ij} given in Table 3.3.2.

The values of P_{ij} in Table 3.3.2 define the probability of seaways in the North Atlantic.

Table 3.3.2
Probability of sea states (x 100000)

T_0 [s] \ H_s [m]	1.5	2.5	3.5	4.5	5.5	6.5	7.5	8.5	9.5	10.5
0.5	0.0	0.0	1.3	133.7	865.6	1186.0	634.2	186.3	36.9	5.6
1.5	0.0	0.0	0.0	29.3	986.0	4976.0	7738.0	5569.7	2375.7	703.5
2.5	0.0	0.0	0.0	2.2	197.5	2158.8	6230.0	7449.5	4860.4	2066.0
3.5	0.0	0.0	0.0	0.2	34.9	695.5	3226.5	5675.0	5099.1	2838.0
4.5	0.0	0.0	0.0	0.0	6.0	196.1	1354.3	3288.5	3857.5	2685.5
5.5	0.0	0.0	0.0	0.0	1.0	51.0	498.4	1602.9	2372.7	2008.3
6.5	0.0	0.0	0.0	0.0	0.2	12.6	167.0	690.3	1257.9	1268.6
7.5	0.0	0.0	0.0	0.0	0.0	3.0	52.1	270.1	594.4	703.2
8.5	0.0	0.0	0.0	0.0	0.0	0.7	15.4	97.9	255.9	350.6
9.5	0.0	0.0	0.0	0.0	0.0	0.2	4.3	33.2	101.9	159.9
10.5	0.0	0.0	0.0	0.0	0.0	0.0	1.2	10.7	37.9	67.5
11.5	0.0	0.0	0.0	0.0	0.0	0.0	0.3	3.3	13.3	26.6
12.5	0.0	0.0	0.0	0.0	0.0	0.0	0.1	1.0	4.4	9.9
13.5	0.0	0.0	0.0	0.0	0.0	0.0	0.0	0.3	1.4	3.5
14.5	0.0	0.0	0.0	0.0	0.0	0.0	0.0	0.1	0.4	1.2
15.5	0.0	0.0	0.0	0.0	0.0	0.0	0.0	0.0	0.1	0.4
16.5	0.0	0.0	0.0	0.0	0.0	0.0	0.0	0.0	0.0	0.1
Sum	0	0	1	165	2091	9280	19922	24879	20870	12898

Table 3.3.2 cont.

T_0 [s] \ H_s [m]	11.5	12.5	13.5	14.5	15.5	16.5	17.5	18.5	SUM
0.5	0.7	0.1	0.0	0.0	0.0	0.0	0.0	0.0	3050
1.5	160.7	30.5	5.1	0.8	0.1	0.0	0.0	0.0	22575
2.5	644.5	160.2	33.7	6.3	1.1	0.2	0.0	0.0	23810
3.5	1114.1	337.7	84.3	18.2	3.5	0.6	0.1	0.0	19128
4.5	1275.2	455.1	130.9	31.9	6.9	1.3	0.2	0.0	13289
5.5	1126.0	463.6	150.9	41.0	9.7	2.1	0.4	0.1	8328
6.5	825.9	386.8	140.8	42.2	10.9	2.5	0.5	0.1	4806
7.5	524.9	276.7	111.7	36.7	10.2	2.5	0.6	0.1	2586
8.5	296.9	174.6	77.6	27.7	8.4	2.2	0.5	0.1	1309
9.5	152.2	99.2	48.3	18.7	6.1	1.7	0.4	0.1	626
10.5	71.7	51.5	27.3	11.4	4.0	1.2	0.3	0.1	285
11.5	31.4	24.7	14.2	6.4	2.4	0.7	0.2	0.1	124
12.5	12.8	11.0	6.8	3.3	1.3	0.4	0.1	0.0	51
13.5	5.0	4.6	3.1	1.6	0.7	0.2	0.1	0.0	21
14.5	1.8	1.8	1.3	0.7	0.3	0.1	0.0	0.0	8
15.5	0.6	0.7	0.5	0.3	0.1	0.1	0.0	0.0	3
16.5	0.2	0.2	0.2	0.1	0.1	0.0	0.0	0.0	1
Sum	6245	2479	837	247	66	16	3	1	100000

Notes: The H_s and T_0 values are coordinates of the midpoints of 1 m and 1 s intervals, respectively.

3.3.3 Where a classified ship is to operate on a specified route, PRS may accept the hull structure complying with the fatigue strength criteria set forth in 2.6.5, with fatigue damage D being determined using the form of Table 3.3.2 and the values assumed for the envisaged route.

The values of P_{ij} are to be based on reliable statistical data and are to be submitted to PRS for acceptance.

3.3.4 Short-term predictions are to be made for the values of ship course angles μ changing with increment not greater than $\frac{\pi}{6}$ rd. Calculations may be thus carried out for $\mu = 0, \frac{\pi}{6}, \frac{2\pi}{6}, \frac{3\pi}{6}, \dots, \frac{11\pi}{6}$ rd, substituting $P_k = \text{const} = \frac{1}{12}$, $N_k = 12$ into formula 3.3.1-1, i.e. treating all values of ship course angles μ as equally probable.

3.4 Fatigue Strength Calculation

3.4.1 To determine the transfer function $Y(\omega)$ of stress ranges $\Delta\sigma$ for hull longitudinal members, we have to superpose the stress ranges due to hull vertical and horizontal bending, hull torsion (for ships with wide hatch openings), as well as local bending induced by sea water (external) and cargo (internal) pressures.

Phase shifts between the above components of stress ranges are to be taken into account.

It is important to note that the functions $Y(\omega)$ are the values of nominal or hot-spot stress ranges (depending on the S-N curve used) in waves of unit amplitude (the amplitude is half the wave height).

3.4.2 The calculations of $Y(\omega)$ are to be carried out for at least 15 values of regular wave frequency ω , uniformly distributed within the interval 0.1 1/s to 1.2 1/s.

3.4.3 The stress ranges $\Delta\sigma$ ($Y(\omega)$ functions) in hull structural members are to be determined according to 4.1. Then, the stress concentration factor is to be applied according to 2.2.8 (where nominal stress ranges with appropriate S-N curves are not used directly) or hot-spot stresses are to be calculated directly according to the requirements of 4.3.

3.4.4 Dynamic pressures, in the waterline region, are to be calculated using a method analogous to that formulated in 2.2.4.3, i.e. the values of pressure ranges at side are to be reduced using coefficient k_d .

The values of T_d (Fig. 2.2.4.3) are to be calculated according to formula (2.2.4.3-2), substituting $k_{pr} = 1$ and p_{db}^* calculated directly at the waterline level (following the long-term prediction), exceeded with a probability level of 10^{-4} .

3.4.5 Dynamic pressures in cargo or ballast water tanks are to be calculated according to formulae given in 2.2.4.4, substituting $k_{pr} = 1$ and calculated directly acceleration amplitudes in regular wave a_L, a_T, a_v . In lieu of dynamic pressure range, the largest of the values $\Delta p_L, \Delta p_T, \Delta p_v$ is to be taken.

3.4.6 The following fatigue strength criterion is to be satisfied:

$$D = \sum_{i=1}^{I_p} \frac{n_i}{N_i} \leq 1 \quad (3.4.5-1)$$

where:

$$n_i = f_1(\Delta\sigma_i) N_L \Delta\sigma_i;$$

f_1 – the probability density function of the long-term stress distribution, calculated according to 3.3.1;

$I_p, \Delta\sigma_i, \Delta\sigma_i$ – as given in 2.6.5;

N_L – number of load cycles during the ship's service, calculated from the formula:

$$N_L = 0,85 a_0 N_s \quad (3.4.5-2)$$

a_0 – parameter calculated according to formula 3.3.1-4;

N_s – number of seconds in the predicted ship's service life (at least 20 years).

N_i in formula 3.4.5-1 denotes the number of load cycles calculated according to S-N curve equation (2.4.3) for the value of stress range corresponding to $\Delta\sigma_i$, corrected in accordance with the requirements of 2.5.

The selection of S-N curves is to be according to the requirements of 2.4; S-N correction is to be made according to the requirements of 2.5.

For structural members not effectively protected against corrosion, the condition defined by equation 2.6.5-3 is to be complied with, calculating D' and D_K' according to formula 3.4.5-1.

4 CALCULATION OF STRESSES USING FINITE ELEMENT METHOD

4.1 Principles of Stress Calculation

4.1.1 Objective of Calculations

Direct calculation of hull stresses using finite element method is necessary or advisable in the following cases:

- the structural member under consideration is not given in Table 2.4.2 (welded joint classification) or the appropriate (required) value of stress concentration factor is not given in 2.2.8;
- the long-term stress range distribution of a structure is calculated directly according to Chapter 3.

4.1.2 Calculation Method

Calculation of stress ranges, the values of which are directly applied to the fatigue strength analysis may be carried out in two stages, in linear-elastic range.

At the first stage, nominal stresses are to be determined by solving the FEM model of a hull structure part or the whole hull. The values of nominal stresses may be applied directly to the fatigue strength calculations using appropriate S-N curves according to Table 2.4.2. The FEM model is to comply with the requirements set forth in 4.1.3. Loads for the model are to be taken according to the *Rules* – where the long-term prediction was not made or is to be calculated directly for a ship in regular wave according to Chapter 3.

At the second stage, hot-spot stresses are to be determined by solving a fine FEM model of the hull structure part under consideration. Detailed requirements for such calculation model are given in 4.2.

In the calculations, the load acting on the model boundaries, corresponding to stress values calculated at the first stage of analysis or the stress values obtained from the solution of girders or stiffeners beam models, is to be applied. Forced displacements of the nodes on the model boundaries can be also applied.

Where hull loads in regular wave are calculated directly, the second stage is to be followed by the long-term prediction for stress ranges made according to the requirements of Chapter 3.

4.1.3 Detailed Requirements for FEM Model Used in Nominal Stresses Calculation

4.1.3.1 Meshing the hull structure (or part thereof) into finite elements is to be such as to allow to determine, with sufficient accuracy, nominal stresses having regard to the following effects:

- hull horizontal and vertical bending and shear;
- hull torsion (in the case of wide hatch openings);
- hull girder bending and shear.

Nominal stresses are to be determined taking into account the effect of stress concentrations due to abrupt geometric changes of the detail, large cut-outs in plates, etc.

If the stress field is more complex than an uniaxial compression/tension field, the greater value of the principal stresses adjacent to the potential crack location is to be used in fatigue strength calculations.

4.1.3.2 The FEM model is to embody at least the halves of two adjacent cargo holds. It is recommended, however, that the FEM model should cover three successive cargo holds.

4.1.3.3 In the case of such ships as container ships, ro-ro ships, passenger ships, catamarans and other floating objects having specific hull arrangement, the FEM model covering the whole hull is recommended.

4.1.3.4 The structure is to be modelled using membrane or shell finite elements.

The stiffened panels are to be modelled using finite elements having orthotropic properties.

Stiffeners may be also modelled using beam elements. It is permitted that the flanges of girders be modelled using rod elements.

A uniform mesh is to be used with smooth transition and avoidance of abrupt changes in mesh size.

4.1.3.5 Loads applied to the FEM model are to be accurately balanced.

The ends of the model, described in 4.1.3.2, are to be loaded with normal and shear stresses, equivalent to bending moments and transverse forces (and possibly torsional moments), determined within the scope of the fatigue strength analysis.

4.1.3.6 When modelling hull structure for FEM calculations and when interpreting the calculation results, the requirements, set forth in PRS Publications “P” concerning the strength analysis of particular ship types (the relevant Publications are mentioned in 2.2.6.6), are to be applied.

4.2 Calculation of Hot-Spot Stresses

4.2.1 Objective and Scope of Calculations

Fine FEM models are to be applied to parts of the hull structure embodying structural details that are susceptible to fatigue cracks (at the notches).

Such models are to be used, in particular, in the calculation of welded stiffeners or girders connected with brackets, the crossing of stiffeners and girders or bulkheads, cut-outs in girder webs, hatchway corners, etc.

4.2.2 Loads for the Model

It is recommended that a fine FEM model of a structural detail be used as super element in a coarse model (4.1.3). Then, when calculating the stresses in the second stage (4.1.2), forced displacements at the model boundaries, obtained from a coarse model solution, may be applied.

If a fine FEM model is developed independently of the coarse model, then the values of loads equivalent to the values of stresses obtained from the solution of a coarse model are to be applied to the boundaries of the model.

The extent of the fine FEM model (its dimensions) is to be ample enough to minimize the effect of approximate boundary loads on the values of stresses in the structural member under consideration, usually located in the middle part of the model.

4.2.3 Calculation of Hot-Spot Stresses

4.2.3.1 General

The majority of hull structural members susceptible to fatigue cracks are characterized by abrupt changes in geometry – particularly in way of perpendicular plates connections. Calculation of stresses in such areas using FEM analysis yields infinitely large values if the finite elements scantlings approach zero.

To interpret correctly the FEM analysis results and to use the results in the fatigue strength calculations on the basis of one S-N curve only (in the present Publication, the DEN “D” curve has been used), irrespective of the structural member features, a precise method of meshing into finite elements, as well as a special procedure, specified in 4.2.4, for extrapolation of stresses in the finite elements to hot-spot stresses, are to be used.

4.2.4 Hot-Spot Stresses Calculation Procedure

4.2.4.1 When developing a fine FEM model for hot-spot stresses calculation. the following principles are to be used:

- the model is to represent an idealized structure geometry. i.e. disregarding accidental misalignments (possible minor misalignments are accounted for in the S-N curve; major misalignments are to be taken into account in the form of an additional stress concentration factor. according to 4.2.4.3);
- the applied meshing near the notch (the weld. in the majority of cases) is to be fine enough to allow stresses to be determined in points used for strain gauges;
- the finite elements applied are to ensure a linear variation of normal stresses in the direction of plate thickness. The application of 4-node shell or 8-node three-dimensional elements is permitted. In case of steep stress gradient. 8-node three-dimensional elements are recommended;
- where shell finite elements are used. the stiffness of the weld intersection is to be taken into account in the FEM model – e.g. by modelling the welds by inclined shell elements. Shell finite elements are to be located in mid-surface of the plate. Three-dimensional finite elements used are to precisely represent the plate thicknesses. as well as location of plates and welds;
- near the notch. (e.g. the crossing of transverse plates edges). the edge lengths of 4-node shell finite elements and 8-node three-dimensional finite elements are to be about the thickness of the plate in which the fatigue crack may initiate. In the case of 8-node shell finite elements. the length of side may be equal to twice the plate thickness;
- in areas located far from the notch. the application of finite elements having larger dimensions is permitted. The increase in element dimensions with the distance from the notch is to be gradual and the aspect ratio is not to be greater than 3;
- hot-spot stresses are to be determined using extrapolation procedure. shown in Fig. 4.2.4.1. Extrapolation is to be made for the values of principal stresses having the largest absolute values. determined on the surface of the plate; the angle by which the direction of the principal stresses deviates from line AB is to be not greater than 45°;
- the principal stresses. which are the basis of extrapolation (Fig. 4.2.4.1). are to be determined by linear extrapolation (in the direction of the weld edge). at points comparable with the extrapolation points used in computer program (usually these are Gauss points). then by linear extrapolation in the direction of AB edge (Fig. 4.2.4.1) and finally. by extrapolation along AB edge;
- where 4-node shell finite elements are used. the principal stresses at the distance of $t/2$ and $3t/2$ from the weld edge. which are the basis of extrapolation. may be determined by linear interpolation of the values of principal stresses on the surface of the plate. in the nodes of particular finite elements lying on AB line.

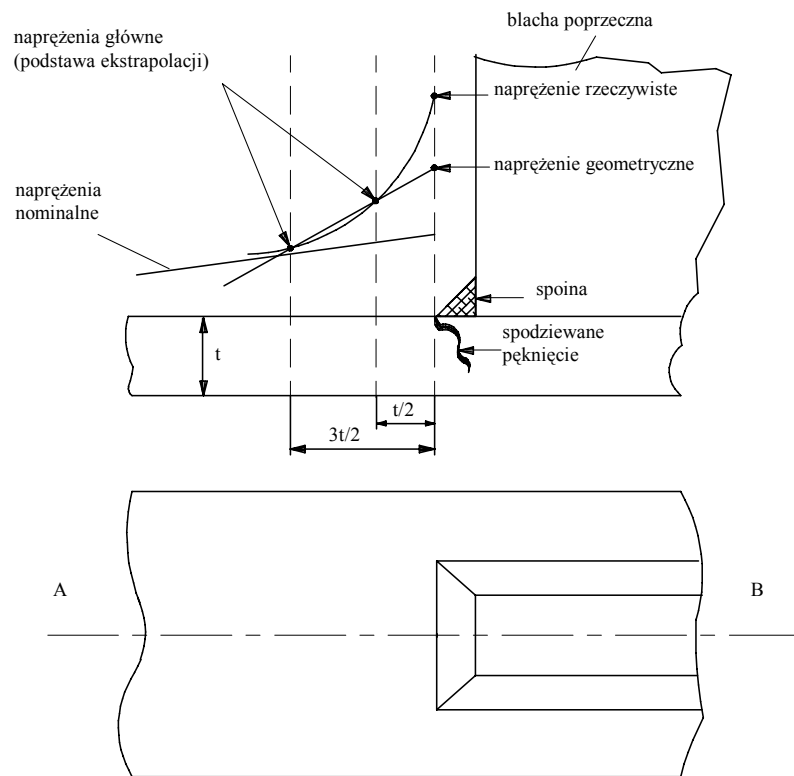

Fig. 4.2.4.1 Definition of hot-spot stresses

4.2.4.2 The values of hot-spot stress ranges, calculated using algorithm given in 4.2.4.1, are to be multiplied by coefficient $C_g = 1.05$. The value so obtained is to be applied to fatigue strength calculations using the “D” curve (2.4.3).

4.2.4.3 If the assembling accuracy significantly departs from the acceptable shipbuilding standard, the values of hot-spot stresses are to be calculated for the real arrangement.

4.2.4.4 When calculating the stresses on the edges of plates (cut-outs in the girder webs, openings in plating, hatch corners, etc.), the dimensions of sides of the finite elements used are to be not greater than the thickness of plate for 4-nodes finite elements and twice the thickness of the plate for 8-nodes finite elements.

The values of principal stresses on the edge of plate may be taken directly as the stresses calculated by computer program in rod elements with negligible rigidity, located along the plate edge.

The values of stresses so obtained are to be directly applied to fatigue strength calculation, using “B” or “C” S-N curve, depending on the plate edge treatment (Table 2.4.2).

4.2.4.5 Where notches in the structure do not allow to calculate hot spot stresses according to 4.2.4.1 or give ambiguous results. PRS may allow that the values of principal stresses in the finite element at the notch will be applied as hot-spot stresses.

4.3 Calculation of Stresses having Regard to Weld Dimensions and Shape

The most advanced method of welded joints fatigue strength analysis is direct calculation of stresses in the weld using the FEM model.

Such model is to comprise a part of the hull structure similar to that presented in 4.2. but the dimensions of the finite elements used in the weld and in the vicinity of the weld are to be even smaller than those required in 4.2.

For plates thicknesses ≥ 5 mm. the following should be observed when developing a FEM model:

- an effective weld root radius of $r = 1$ mm is to be considered;
- flank angles of 30° for butt welds and 45° for fillet welds may be considered.

The application of such FEM calculation method and the selection of the appropriate S-N curve will be specially considered by PRS after verification of the submitted calculation results.