

# *Polski Rejestr Statków*

INFORMATIVE PUBLICATION NO. 16/I

**SHIPBUILDING AND REPAIR QUALITY STANDARD**

**2018**

July

Publications I (Informative) are issued by Polski Rejestr Statków S.A.  
as guidance or explanatory notes to PRS Rules.



GDĄŃSK

*Publication No. 16/I – Shipbuilding and Repair Quality Standard – July 2018*, was accepted by Director for Ship Division of Polski Rejestr Statków S.A. and enters into force on 1 July 2018.

This Publication replaces *Publication No 16/I – Shipbuilding and Repair Quality Standard – 2014*.

## REFERENCES

1. Rules for the Classification and Construction of Sea-going Ships, Part I – Classification Regulations.
2. Rules for the Classification and Construction of Sea-going Ships, Part II – Hull.
3. Rules for the Classification and Construction of Sea-going Ships, Part IX – Materials and Welding.
4. Publication No. 36/P – Hull Survey of Oil Tankers.
5. Publication No. 39/P – Hull Survey of Bulk Carriers.
6. Publication No. 46/P – Hull Surveys of Chemical Tankers
7. Publication No 48/P – Requirements Concerning Gas Tankers
8. Publication No 49/P – Requirements Concerning Mobile Offshore Drilling Units
9. Publication No. 58/P – Hull Surveys of Double Hull Oil Tankers.
10. Publication No. 62/P – Hull Survey of General Dry Cargo Ships
11. Publication No. 63/P – Replacement Criteria for Side Shell Frames and Brackets in Single Side Skin Bulk Carriers and Oil-Bulk-Ore Carriers
12. Publication No. 64/P – Hull Surveys of Double Skin Bulk Carriers
13. Publication No. 74/P – Principles for Welding Procedure Qualification Tests.
14. Publication No. 80/P – Non-destructive Testing.
15. Publication No. 81/P – Hull Surveys for New Construction.
16. Publication No. 84/P – Requirements Concerning the Construction and Strength of the Hull and Hull Equipment of Sea-going Bulk Carriers of 90 m in Length and above.
17. Publication No. 85/P – Requirements Concerning the Construction and Strength of the Hull and Hull Equipment of Sea-going, Double Hull Oil Tankers of 150 m in Length and above.

## ADDITIONAL GUIDANCE

1. IACS – [Recommendation No.76 Bulk Carriers – Guidelines for Surveys, Assessment and Repair of Hull Structure.](#)
2. TSCF – Guidelines for the Inspection and Maintenance of Double Hull Tanker Structures.
3. TSCF – Guidance Manual for the Inspection and Condition Assessment of Tanker Structures.
4. IACS – [Recommendation No.96 Double Hull Oil Tankers – Guidelines for Surveys, Assessment and Repair of Hull Structure.](#)
5. IACS – [Recommendation No.55 General Dry Cargo Ships – Guidelines for Surveys, Assessment and Repair of Hull Structure.](#)
6. IACS – [Recommendation No.84 Container Ships – Guidelines for Surveys, Assessment and Repair of Hull Structure.](#)

© Copyright by Polski Rejestr Statków S.A., 2018

# CONTENTS

page

<b>PART A – Shipbuilding and Remedial Quality Standard for New Construction</b> .....	5
<b>1 Scope</b> .....	5
<b>2 General Requirements for New Construction</b> .....	5
<b>3 Qualification of Personnel and Procedures</b> .....	6
3.1 Qualification of Welders.....	6
<b>4 Materials</b> .....	6
4.1 Materials for Structural Members.....	6
4.2 Surface Conditions .....	6
<b>5 Gas Cutting</b> .....	8
<b>6 Fabrication and Fairness</b> .....	9
6.1 Flanged Longitudinals and Flanged Brackets (see Table 6.1) .....	9
6.2 Built up Sections (see Table 6.2).....	10
6.3 Corrugated Bulkheads (see Table 6.3).....	11
6.4 Pillars, Brackets and Stiffeners (see Table 6.4) .....	12
6.5 Maximum Heating Temperature on Surface for Line Heating (see Table 6.5) .....	13
6.6 Block Assembly (see Table 6.6).....	13
6.7 Special Sub-assembly (see Table 6.7) .....	14
6.8 Shape (see Tables 6.8-1 and 6.8-2) .....	14
6.9 Fairness of Plating between Frames (see Table 6.9).....	15
6.10 Fairness of Plating with Frames (see Table 6.10).....	16
6.11 Preheating for Welding Hull Steels at Low Temperature (see Table 6.11) .....	16
<b>7 Alignment</b> .....	16
<b>8 Welding Joint Details</b> .....	18
<b>9 Remedial</b> .....	24
9.1 Typical Misalignment Remedial – see Tables 9.1-1 to 9.1-3.....	24
9.2 Typical Butt Weld Plate Edge Preparation Remedial (Manual and Semi-automatic Welding) – see Tables 9.2-1 i 9.2-2.....	26
9.3 Typical Fillet Weld Plate Edge Preparation Remedial (Manual and Semi-automatic Welding) – see Tables 9.3-1 do 9.3-3 .....	28
9.4 Typical Fillet and Butt Weld Profile Remedial (Manual and Semi-automatic Welding) – see Table 9.4.....	30
9.5 Distance between Welds Remedial – see Table 9.5.....	31
9.6 Erroneous Hole Remedial – see Table 9.6.....	31
9.7 Remedial by Insert Plate – see Table 9.7.....	32
9.8 Weld Surface Remedial – see Table 9.8.....	32
9.9 Welding Remedial by Short Bead (see Table 9.9).....	33
<b>PART B – Repair Quality Standard for Existing Ships</b> .....	34
<b>1 Scope</b> .....	34
<b>2 General Requirements for Repairs and Repairers</b> .....	34
<b>3 Qualification of Personnel</b> .....	35
3.1 Qualification of Welders.....	35
<b>4 Materials</b> .....	35
4.1 General Requirements for Materials.....	35
4.2 Equivalency of Material Grades .....	36

<b>5</b>	<b>General Requirements to Welding</b> .....	38
5.1	Correlation of Welding Consumables with Hull Structural Steels.....	38
5.2	General Requirements to Preheating and Drying Out.....	38
5.3	Dry Welding on Hull Plating below the Waterline of Vessels Afloat .....	38
<b>6</b>	<b>Repair Quality Standard</b> .....	39
6.1	Welding, General .....	39
6.2	Renewal of Plates.....	39
6.3	Doublers on Plating .....	40
6.4	Renewal of Internals/Stiffeners.....	41
6.5	Renewal of Internals/Stiffeners – Transitions Inverted Angle/Bulb Profile .....	41
6.6	Application of Doubling Straps .....	42
6.7	Welding of Pitting Corrosion .....	43
6.8	Welding Repairs for Cracks.....	43

**PART A**

**SHIPBUILDING AND REMEDIAL QUALITY STANDARD FOR NEW  
CONSTRUCTION**

**1 SCOPE**

It is intended that this *Publication* provides guidance where established and recognized shipbuilding or national standards accepted by PRS do not exist.

**1.1** This *Publication* provides guidance on shipbuilding quality standards for the hull structure during new construction and the remedial standard where the quality standard is not available.

Whereas the *Publication* generally applies to:

- conventional merchant ship types,
  - parts of hull covered by the rules of Polski Rejestr Statków,
  - hull structures constructed from normal and higher strength hull structural steel,
- the applicability of the standard is in each case to be agreed upon by PRS.

The *Publication* does generally not apply to the new construction of special types of ships as e.g. gas tankers structures fabricated from stainless steel or other, special types or grades of steel.

**1.2** In this *Publication*, both a "Standard" range and a "Limit" range are listed. The "Standard" range represents the target range expected to be met in regular work under normal circumstances. The "Limit" range represents the maximum allowable deviation from the "Standard" range. Work beyond the "Standard" range but within the "Limit" range is acceptable.

**1.3** The *Publication* covers typical construction methods and gives guidance on quality standards for the most important aspects of such construction. Unless explicitly stated elsewhere in the *Publication*, the level of workmanship reflected herein will in principle be acceptable for primary and secondary structure of conventional designs. A more stringent standard may however be required for critical and highly stressed areas of the hull, and this shall be agreed with PRS in each case. In assessing the criticality of hull structure and structural components, reference is made to Additional Guidance, see page 2.

**1.4** Details relevant to structures or fabrication procedures not covered by this *Publication* shall be approved by PRS on the basis of procedure qualifications and/or recognized national standards.

**1.5** For use of this *Publication*, fabrication fit-ups, deflections and similar quality attributes are intended to be uniformly distributed about the nominal values. The shipyard shall take corrective action to improve work processes that produce measurements where a skew distribution is evident. Relying upon remedial steps that truncate a skewed distribution of the quality attribute is unacceptable.

**2 GENERAL REQUIREMENTS FOR NEW CONSTRUCTION**

**2.1** In general, the work shall be performed in accordance with PRS *Rules* and under the supervision of the Surveyor to PRS.

**2.2** Welding operations shall be performed in accordance with work instructions (WPS) accepted by PRS.

**2.3** Welding of hull structures shall be performed by qualified welders, according to approved and qualified welding procedures and with welding consumables approved by PRS. Welding operations shall be performed under proper supervision by the shipbuilder. The working conditions for welding shall be monitored by PRS in accordance with *Publication 81/P – Hull Surveys for New Construction*.

### **3 QUALIFICATION OF PERSONNEL AND PROCEDURES**

#### **3.1 Qualification of welders**

**3.1.1** Welders shall be qualified in accordance with the binding standards concerning welders qualification (e.g. EN 287-1 or ISO 9606-1). Recognition of qualification by other bodies based on these standards or other standards, such as AWS is subject to submission them to PRS for evaluation. Subcontractors shall keep records of welder's qualification and, when required, furnish valid approval test certificates.

**3.1.2** Welding operators using fully mechanized or fully automatic processes need generally not pass approval testing provided that the production welds made by the operators are of the required quality. However, operators shall receive adequate training in setting or programming and operating the equipment. Records of training and operation experience shall be maintained on individual operator's files and records, and be made available to PRS for inspection when requested.

**3.2** Welding procedures shall be qualified in accordance with *Publication 74/P – Principles for Welding Procedure Qualification* or other recognized international or national standards (e.g. EN ISO 15607, EN ISO 15610, EN ISO 15611, EN ISO 15612, EN ISO 15613, EN ISO 15614-1 or EN ISO 15614-2). Recognition by other institution acc. to these standards or other standards e.g. AWS is subject to submission to PRS for evaluation. The welding procedure shall be supported by a welding procedure qualification record. The specification shall include the welding process, types of electrodes, weld shape, edge preparation, welding techniques and positions.

**3.3** Personnel performing non-destructive examination for the purpose of assessing quality of welds in connection with new construction covered by this *Publication*, shall be qualified in accordance with a recognized international or national qualification scheme (e.g. EN-ISO 9712). Records of operators and their current authorization shall be kept and made available to the Surveyor for inspection when requested.

### **4 MATERIALS**

#### **4.1 Materials for structural members**

All materials, including weld consumables, to be used for the structural members shall be approved by PRS as per the approved construction drawings and meet the respective PRS Rules requirements. Additional recommendations are contained in the following paragraphs.

All materials used shall be manufactured at works approved by PRS.

Welding consumables shall be approved by PRS for the type and grade supplied.

#### **4.2 Surface conditions**

##### **4.2.1 Definitions**

**Minor imperfections** – pitting, rolled-in scale, indentations, roll marks, scratches and grooves.

**Defects** – cracks, shells, sand patches, sharp edged seams and minor imperfections not exceeding the limits of Table 4.2.2.

**Depth of imperfections or defects** – the depth shall be measured from the surface of the product.

##### **4.2.2 Acceptance without remedies**

Minor imperfections, in accordance with the nominal thickness ( $t$ ) of the product and the limits described in Table 4.2.2, are permissible and may be left as they are.

**Table 4.2.2**  
**Limits for depth of minor imperfection, for acceptance without remedies**

Material thickness	Max depth [mm]		
	Imperfection surface area, [%]	15 ~ 20%	5 ~ 15%
$t < 20$ mm	0.2 mm	0.4 mm	0.5 mm
$20 \text{ mm} \leq t < 50$ mm	0.2 mm	0.6 mm	0.7 mm
$50 \text{ mm} \leq t$	0.2 mm	0.7 mm	0.9 mm

Imperfection surface area ratio (%) is obtained as influenced area / area under consideration (i.e. plate surface area) x 100%.

For isolated surface discontinuities, influenced area is obtained by drawing a continuous line which follows the circumference of the discontinuity at a distance of 20 mm. (Fig. 4.2.2 (a)).

For surface discontinuities appearing in a cluster, influenced area is obtained by drawing a continuous line which follows the circumference of the cluster at a distance of 20 mm. (Fig. 4.2.2 (b)).

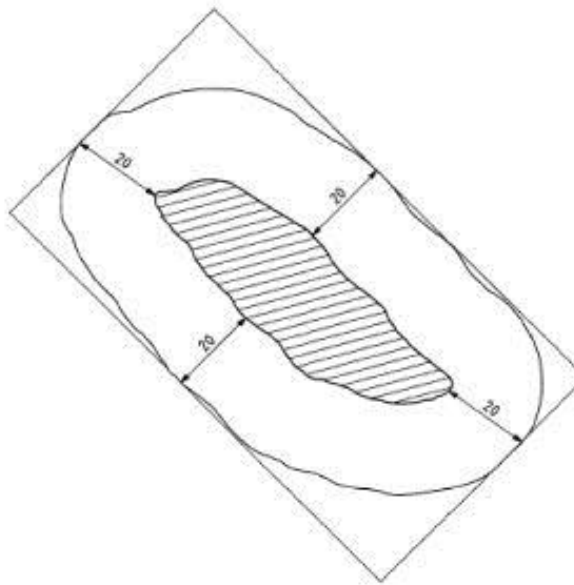


Fig. 4.2.2 (a) – Determination of the area influenced by an isolated discontinuity  
 (Re. EN 10163-1:2004+AC:2007 E)

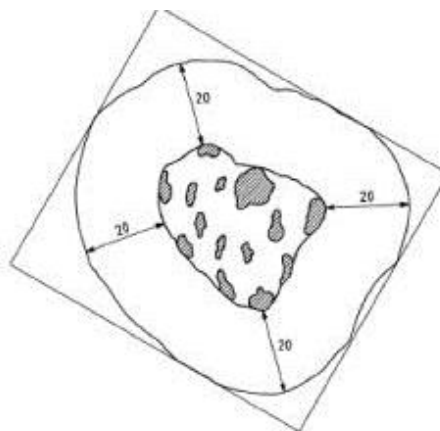


Fig. 4.2.2 (b) – Determination of the area influenced by clustered discontinuities  
 (Re. EN 10163-1:2004+AC:2007 E)

### 4.2.3 Remedial of defects

Defects (see 4.2.1) shall be remedied by grinding and/or welding in accordance with the requirements of paragraph 3 of *Part IX of the PRS Rules for the Classification and Construction of Sea-going Ships* and Table 9.14 of this *Publication*.

### 4.2.4 Further defects

#### 4.2.4.1 Lamination

Investigation to be performed at the steelmill into the cause and extent of the detected laminations. Severe lamination shall be remedied by local insert plates. The minimum breadth or length of the plate to be replaced shall be:

- 1600 mm for shell and strength deck plating in way of cruciform or T-joints,
- 800 mm for shell, strength deck plating and other primary members,
- 300 mm for other structural members.

Local limited lamination may be remedied by chipping and/or grinding followed by welding in accordance with sketch 4.2.4 (a). In case where the local limited lamination is near the plate surface, the remedial may be performed as shown in sketch 4.2.4 (b). For limitations see paragraph 4.2.2.



Fig. 4.2.4

#### 4.2.4.2 Weld spatters

Loose weld spatters shall be removed by grinding or other measures to clean metal surface (see Table 9.13), as required by the paint system, on:

- shell plating,
- deck plating on exposed decks,
- in tanks for chemical cargoes,
- in tanks for fresh water and for drinking water,
- in tanks for lubricating oil, hydraulic oil, including service tanks.

## 5 GAS CUTTING

The roughness of the cut edges shall meet the following requirements:

#### Free Edges:

Items	Standard value	Limit value
Strength Members	150 $\mu\text{m}$	300 $\mu\text{m}$
Others	500 $\mu\text{m}$	1000 $\mu\text{m}$

#### Welding Edges:

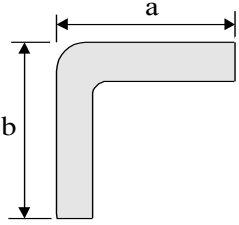
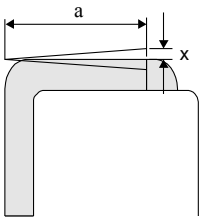
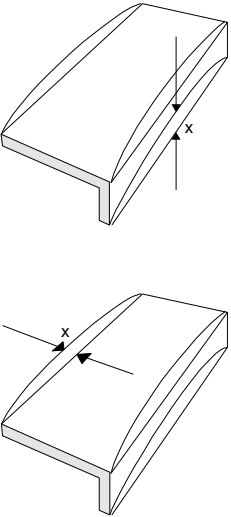
Items	Standard value	Limit value
Strength Members	400 $\mu\text{m}$	800 $\mu\text{m}$
Others	800 $\mu\text{m}$	1500 $\mu\text{m}$



## 6 FABRICATION AND FAIRNESS

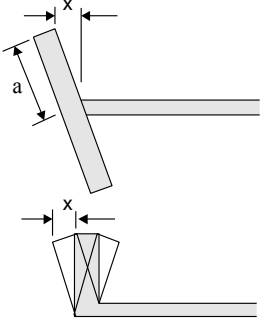
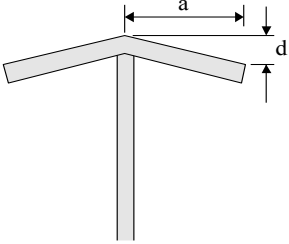
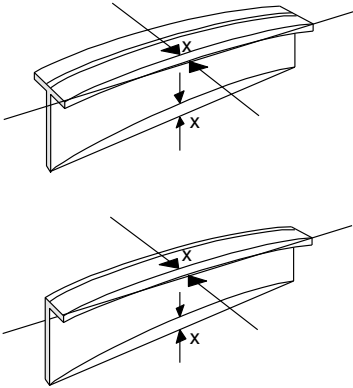
### 6.1 Flanged longitudinals and flanged brackets (see Table 6.1)

**Table 6.1**  
**Flanged Longitudinals and Flanged Brackets**

Detail	Standard value $x$ [mm]	Limit value $x$ [mm]	Notes
Breadth of flange 	$\pm 3$	$\pm 5$	$x$ – compared to correct size: $a, b$
Angle between flange and web  compared to template	$\pm 3$	$\pm 5$	per 100 mm of $a$
Straightness in plane of flange and web 	$\pm 10$	$\pm 25$	per 10 m

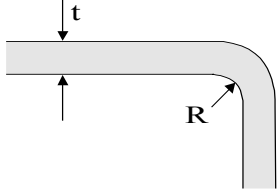
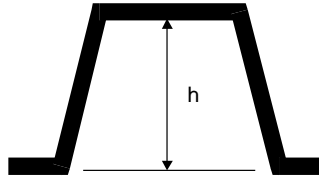
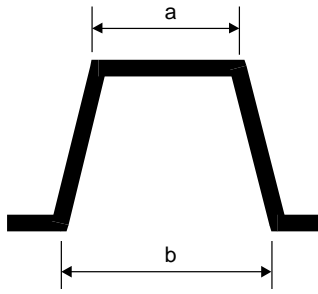
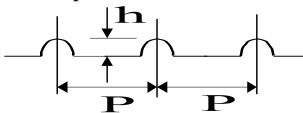
**6.2 Built up sections (see Table 6.2)**

**Table 6.2  
Built up sections**

Detail	Standard value $x$ [mm]	Limit value $x$ [mm]	Notes
<p>Frames and longitudinals</p> 	$\pm 1.5$	$\pm 3$	per 100 mm of $a$
<p>Distortion of face plate</p> 	$d < 3 + a/100$	$d < 5 + a/100$	
<p>Distortion in plane of web and flange of built up longitudinal frame, transverse frame, girder and transverse web</p> 	$\pm 10$	$\pm 25$	per 10 m in length

### 6.3 Corrugated bulkheads (see Table 6.3)

**Table 6.3**  
**Corrugated bulkheads**

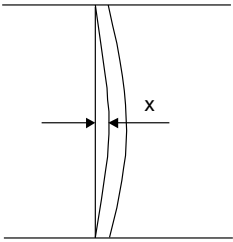
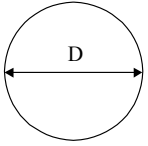
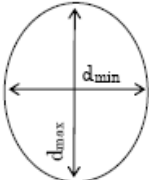
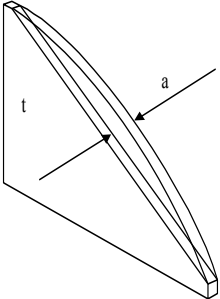
Detail	Standard	Limit	Notes
Mechanical bending 	$R \geq 3t$ mm  $R \geq 4,5t$ mm for CSR ships <sup>1)</sup>	$R \geq 2t$ mm <sup>2)</sup>	Material to be suitable for cold flanging (forming) and welding in way of radius
Depth of corrugation 	$\pm 3$ mm	$\pm 6$ mm	Tolerances
Breadth of corrugation 	$\pm 3$ mm	$\pm 6$ mm	Tolerances
Pitch and depth of swedged corrugated bulkhead compared with correct value 	$h: \pm 2,5$ mm $h: \pm 5$ mm Where it is not aligned with other bulkheads $P: \pm 6$ mm $P: \pm 9$ mm Where it is aligned with other bulkheads $P: \pm 2$ mm $P: \pm 3$ mm		Tolerances

Notes:

- 1) For CSR Bulk Carriers built under the “Common Structural Rules for Bulk Carriers” with the effective dates of 1 July 2010 and 1 July 2012, the standard is  $R \geq 2t$  mm.
- 2) For CSR ships, the allowable inside bending radius of cold formed plating may be reduced provided the following requirements are fulfilled:
  - When the inside bending radius is reduced below 4.5 times the as built plate thickness, supporting data shall be provided. The bending radius shall in no case be less than 2 times the as-built plate thickness. As a minimum, the following additional requirements shall be fulfilled:
    - a) For all bent plates:
      - 100% visual inspection of the bent area shall be performed;
      - Random checks by magnetic particle testing shall be performed.
    - b) In addition to a), for corrugated bulkheads subject to lateral liquid pressure, the steel shall be of Grade D/DH or higher. The material is impact tested in the strain-aged condition and satisfies the requirements stated herein. The deformation shall be equal to the maximum deformation to be applied during production, calculated by the formula  $t_{as-built} / (r_{bdg} + t_{as-built})$ , where  $t_{as-built}$  is the as-built thickness of the plate material and  $r_{bdg}$  is the bending radius. One sample shall be plastically strained at the calculated deformation or 5%, whichever is greater and then artificially aged at 250°C for one hour then subject to Charpy V-notch testing. The average impact energy after strain ageing shall fulfil the impact requirements specified for the grade of steel use.

6.4 Pillars, brackets and stiffeners (see Table 6.4)

**Table 6.4**  
**Pillars, brackets and stiffeners**

Detail	Standard value [mm]	Limit value [mm]	Notes
<p>Pillar (between decks)</p> 	$x \leq 4$	$x \leq 6$	
<p>Cylindrical structure diameter (pillars, masts, posts, etc.)</p> 	$\pm D/200$ (max. + 5)	$\pm D/150$ (max. 7.5)	
<p>Ovality of cylindrical structure</p> 		$d_{\max} - d_{\min} < 0.02$ $d_{\max}$	
<p>Tripping bracket and small stiffener, distortion at the part of free edge</p> 	$a < t/2$	$t$	

## 6.5 Maximum heating temperature on surface for line heating (see Table 6.5)

**Table 6.5**  
**Maximum heating temperature on surface for line heating of higher strength hull steels**

Item		Standard value	Limit value	Notes
Conventional process AH32-EH32 AH36-EH36	Water cooling just after heating	Under 650 °C		
TMCP type AH36-EH36 (CEV > 0,38%)	Air cooling after heating	Under 900 °C		
	Air cooling and subsequent water cooling after heating	Under 900 °C (starting temperature of water cooling to be under 500 °C)		
TMCP type AH32-DH32 AH36-DH36 (CEV ≤ 0,38%)	Water cooling just after heating or air cooling	Under 1000 °C		
TMCP type EH32 & EH36 (CEV ≤ 0,38%)	Water cooling just after heating or air cooling	Under 900 °C		
<p>Note: Carbon equivalent (CEV) for higher strength hull steels shall be calculated as below:</p> $CEV = C + \frac{Mn}{6} + \frac{Cr + Mo + V}{5} + \frac{Ni + Cu}{15}, \quad [\%]$				

## 6.6 Block assembly (see Table 6.6)

**Table 6.6**  
**Block assembly**

Item	Standard value [mm]	Limit value [mm]	Notes
<b>Flat Plate Assembly</b>			
Length and Breadth	± 4	± 6	
Distortion	± 10	± 20	
Squareness	± 5	± 10	
Deviation of interior members from plate	5	10	
<b>Curved plate assembly</b>			
Length and Breadth	± 4	± 8	measured along the girth
Distortion	± 10	± 20	
Squareness	± 10	± 15	
Deviation of interior members from plate	5	10	
<b>Flat cubic assembly</b>			
Length and Breadth	± 4	± 6	
Distortion	± 10	± 20	
Squareness	± 5	± 10	
Deviation of interior members from plate	5	10	
Twist	± 10	± 20	
Deviation between upper and lower plate	± 5	± 10	
<b>Curved cubic assembly</b>			
Length and Breadth	± 4	± 8	measured along with girth
Distortion	± 10	± 20	
Squareness	± 10	± 15	
Deviation of interior members from plate	± 5	± 10	
Twist	± 15	± 25	
Deviation between upper and lower plate	± 7	± 15	

## 6.7 Special sub-assembly (see Table 6.7)

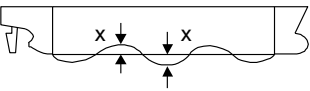
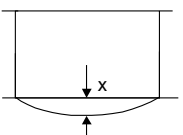
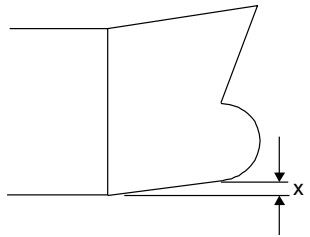
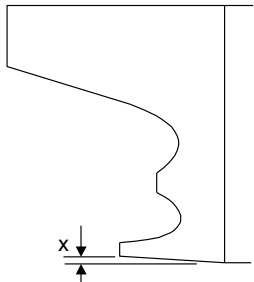
**Table 6.7**  
**Special sub-assembly**

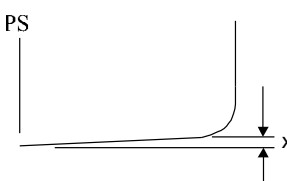
Item	Standard value [mm]	Limit value [mm]	Notes
Distance between upper/lower gudgeon	± 5	± 10	
Distance between aft edge of boss and aft peak bulkhead	± 5	± 10	
Twist of sub-assembly of stern frame	5	10	
Deviation of rudder from shaft center line	4	8	
Twist of rudder plate	6	10	
Flatness of top plate of main engine bed	5	10	
Breadth and length of top plate of main engine bed	± 4	± 6	

**Note:** Dimensions and tolerances have to fulfill engine and equipment manufacturers' requirements, if any.

## 6.8 Shape (see Tables 6.8-1 and 6.8-2)

**Table 6.8-1**  
**Shape**

Detail	Standard value $x$ [mm]	Limit value $x$ [mm]	Notes
1	2	3	4
Deformation for the whole length 	± 50		per 100 m against the line of keel sighting
Deformation for the distance between two adjacent bulkheads 	± 15		
Cocking-up of fore body 	± 30		The deviation shall be measured from the design line.
Cocking-up of aft-body 	± 20		

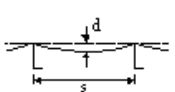
1	2	3	4
Rise of floor amidships 	± 15		The deviation shall be measured from the design line.

**Table 6.8-2**  
**Shape**

Item	Standard value [mm]	Limit value [mm]	Notes
Length between perpendiculars	$\pm L/1000$ (where $L$ is in mm)		Applied to ships of 100 metres length and above. For the convenience of the measurement the point where the keel is connected to the curve of the stem may be substituted for the fore perpendicular in the measurement of the length.
Moulded breadth at midship	$\pm B/1000$ (where $B$ is in mm)		Applied to ships of 15 metres breadth and above, measured on the upper deck.
Moulded depth at midship	$\pm D/1000$ (where $D$ is in mm)		Applied to ships of 10 metres depth and above, measured up to the upper deck

## 6.9 Fairness of plating between frames (see Table 6.9)

**Table 6.9**  
**Fairness of plating between frames**

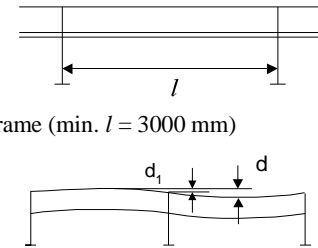
Item		Standard value $d$ [mm]	Limit value $d$ [mm]	Notes
Shell plate	Parallel part (side & bottom shell)	4	8	
	Fore and aft part	5		
Tank top plate	4			
Bulkhead	Longl. Bulkhead	6	8	
	Trans. Bulkhead			
	Swash Bulkhead			
Strength deck	Parallel part	4	8	
	Fore and aft part	6	9	
	Covered part	7	9	
Second deck	Bare part	6	8	
	Covered part	7	9	
Forecastle deck	Bare part	4	8	
Poop deck	Covered part	6	9	
Superstructure deck	Bare part	4	6	
	Covered part	7	9	
House wall	Outside wall	4	6	
	Inside wall	6	8	
	Covered part	7	9	
Interior member (web of girder, etc)		5	7	
Floor and girder in double bottom		5	8	

## 6.10 Fairness of plating with frames (see Table 6.10)

**Table 6.10**  
**Fairness of plating with frames**

Item		Standard value $d, d_1$ [mm]	Limit value $d, d_1$ mm]	Notes
Shell plate	Parallel part	$\pm 2l/1000$	$\pm 3l/1000$	$l$ – span of frame (mm) to be measured between one trans. space (min. $l = 3000$ mm)
	Fore and aft part	$\pm 3l/1000$	$\pm 4l/1000$	
Strength deck (excluding cross deck) and top plate of double bottom	—	$\pm 3l/1000$	$\pm 4l/1000$	
Bulkhead	—		$\pm 5l/1000$	
Accommodation above the strength deck and others	—	$\pm 5l/1000$	$\pm 6l/1000$	



$l = \text{span of frame (min. } l = 3000 \text{ mm)}$

## 6.11 Preheating for welding hull steels at low temperature (see Table 6.11)

**Table 6.11**  
**Preheating for welding hull steels at low temperature**

Steel		Standard value		Limit value	Notes
		Base metal temperature for steel needing preheating	Minimum preheating temperature		
Normal strength steels	A, B, D, E	Below $-5\text{ }^{\circ}\text{C}$	20 $^{\circ}\text{C}^{1)}$		
Higher strength steels (TMCP type)	AH32 – EH 32 AH36 – EH 36	Below $0\text{ }^{\circ}\text{C}$			
Higher strength steels (conventional type)	AH32 – EH 32 AH36 – EH 36	Below $0\text{ }^{\circ}\text{C}$			

**Note:** <sup>1)</sup> This level of preheat shall be applied unless the approved welding procedure specifies a higher level.

## 7 ALIGNMENT

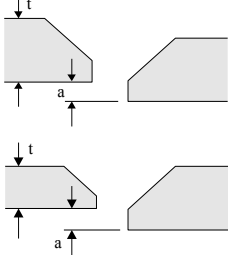
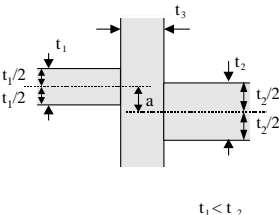
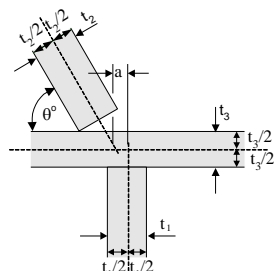
The quality standards for alignment of hull structural components during new construction are shown in Tables 7.1, 7.2 and 7.3. PRS may require a closer construction tolerance in areas requiring special attention\*, as follows:

- regions exposed to high stress concentrations,
- fatigue prone areas,
- detail design block erection joints,
- high tensile steel regions.

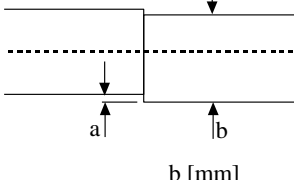
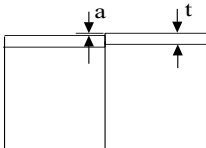
\* See Table 11.1.1.3.1 in Publication 84/P, [10]

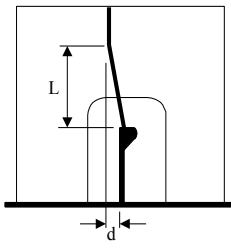
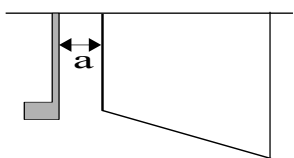
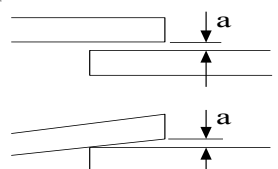


**Table 7-1  
Alignment**

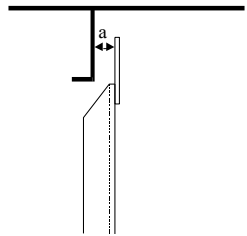
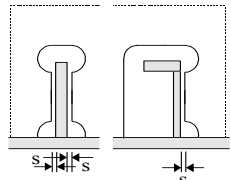
Detail	Limit value [mm]	Notes
<p>Alignment of butt welds</p> 	<p>for strength members <math>a &lt; 0.15 t</math> for other members <math>a &lt; 0.2 t</math>, but maximum 4.0 mm</p>	<p><math>t</math> is the lesser plate thickness</p>
<p>Alignment of fillet welds</p> 	<p>Strength members and higher stress members: <math>a &lt; t_1/3</math> Others: <math>a &lt; t_1/2</math></p>	<p>Alternatively, heel line can be used to check the alignment</p> <p>Where <math>t_3 &lt; t_1</math>, then <math>t_3</math> shall be substituted for <math>t_1</math> in the standard</p>
<p>Alignment of fillet welds</p> 	<p>Strength members and higher stress members: <math>a &lt; t_1/3</math> Others: <math>a &lt; t_1/2</math></p>	<p>Alternatively, heel line can be used to check the alignment</p> <p>Where <math>t_3 &lt; t_1</math>, then <math>t_3</math> shall be substituted for <math>t_1</math> in the standard</p>

**Table 7-2  
Alignment**

Detail	Standard value [mm]	Limit value [mm]	Notes
1	2	3	4
<p>Alignment of flange of T-longitudinal</p> 	<p>Strength members: <math>a &lt; 0.04b</math></p>	<p><math>a = 8.0</math></p>	
<p>Alignment of height of T-bar, L-angle bar or bulb</p> 	<p>Strength members: <math>a &lt; 0.15t</math> Others: <math>a &lt; 0.20t</math></p>	<p><math>a = 3.0</math></p>	

1	2	3	4
Alignment of panel stiffener 	$d < L/50$		
Gap between bracket/intercostal and stiffener 	$a < 2.0$	$a = 3.0$	
Alignment of lap welds 	$a \leq 2.0$	$a = 3.0$	

**Table 7-3  
Alignment**

Detail	Standard value [mm]	Limit value [mm]	Notes
Gap between beam and frame 	$a < 2.0$	$a = 5.0$	
Gap around stiffener cut-out 	$s < 2.0$	$s = 3.0$	

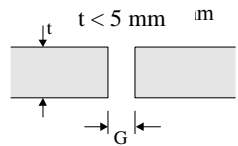
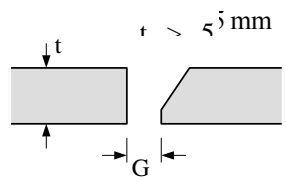
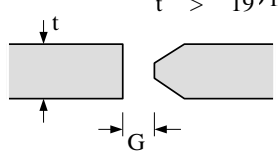
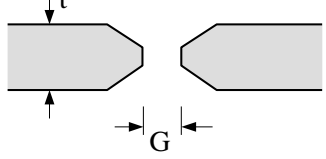
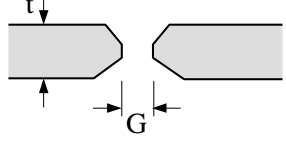
## 8 WELDING JOINT DETAILS

Edge preparation (weld groove size and shape) shall be qualified in accordance with *Publication 74/P* or other recognized standard accepted by PRS.

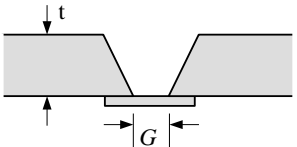
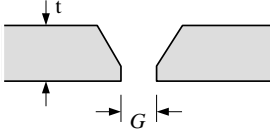
Some typical edge preparations are shown in Tables 8.1-1, 8.1-2, 8.2-1, 8.2-2, 8.4 for reference. The tables give information on *G* gap for these edge preparations.

**8.1 Typical butt weld plate edge preparation (manual and semi-automatic welding) for reference**  
 - see Tables 8.1-1 and 8.1-2

**Table 8.1-1**  
**Typical butt weld plate edge preparation (manual and semi-automatic welding) for reference**

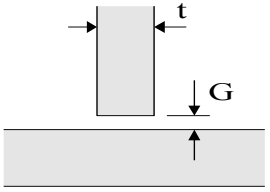
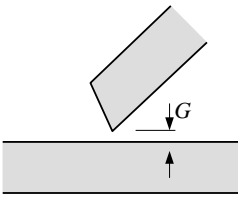
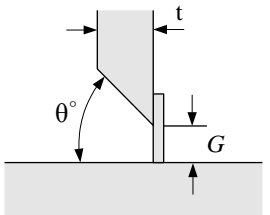
Detail	Standard value $G$ [mm]	Limit value $G$ [mm]	Notes <sup>1)</sup>
Square butt – weld „I” 	< 3	5	
Single bevel butt – weld „1/2Y” 	< 3	5	
Double bevel butt – weld „K” 	< 3	5	
Double vee butt, uniform bevels – weld „X” 	< 3	$G = 5$	
Double vee butt, non-uniform bevel – weld „X” 	< 3	5	
1) Plate edge preparation may be accepted or approved by PRS in accordance with item 7 of Reference Publications or other recognized standard accepted by PRS. For welding procedures other than manual welding, see paragraph 3.2 Qualification of weld procedures.			

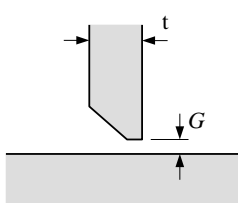
**Table 8.1-2**  
**Typical butt weld plate edge preparation (manual and semi-automatic welding) for reference**

Detail	Standard value $G$ [mm]	Limit value $G$ [mm]	Notes <sup>1)</sup>
Single Vee butt, one side welding with backing strip (temporary or permanent) 	3 ÷ 9	16	
Single vee butt – weld “ Y “ 	< 3	5	
<b>Note 1:</b> Plate edge preparation may be accepted or approved by PRS in accordance with item 7 of Reference Publications or other recognized standard accepted by PRS. For welding procedures other than manual welding, see paragraph 3.2 Qualification of weld procedures.			

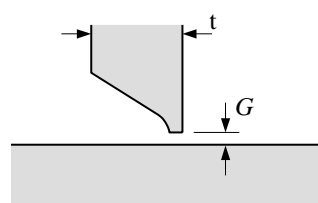
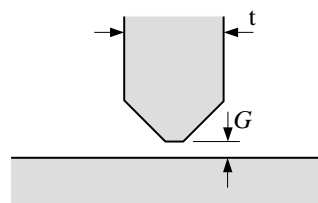
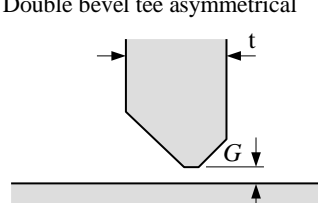
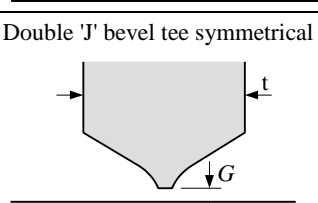
**8.2 Typical fillet weld plate edge preparation (manual and semi-automatic welding) for reference**  
 - see Tables 8.2-1 i 8.2-2

**Table 8.2-1**  
**Typical fillet weld plate edge preparation (manual and semi-automatic welding) for reference**

Detail	Standard value	Limit value	Notes
1	2	3	4
Tee Fillet 	$G < 2 \text{ mm}$	$G = 3 \text{ mm}$	see Note 1
Inclined fillet 	$G < 2 \text{ mm}$	$G = 3 \text{ mm}$	see Note 1
Single bevel tee with permanent backing 	$G < 4 - 6 \text{ mm}$ $\theta = 30^\circ - 45^\circ$	$G = 16 \text{ mm}$	Not normally for strength member see Note 1

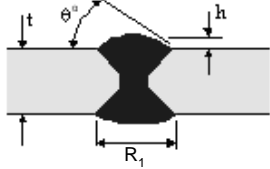
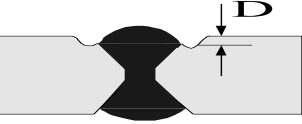
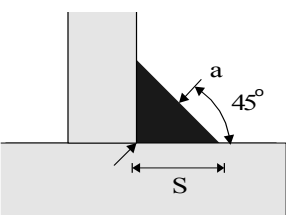
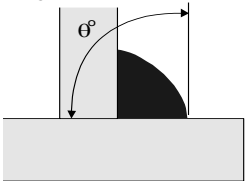
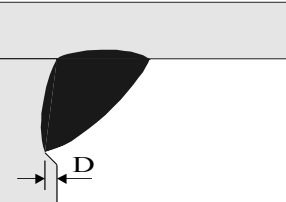
1	2	3	4
Single bevel tee 	$G < 3 \text{ mm}$		see Note 1
<b>Note 1:</b> Plate edge preparation may be accepted or approved by PRS in accordance with item 7 of Reference Publications or other recognized standard accepted by PRS. For welding procedures other than manual welding, see paragraph 3.2 Qualification of weld procedures			

**Table 8.2-2**  
**Typical fillet weld plate edge preparation (manual welding and semi-automatic welding)**  
**for reference**

Detail	Standard value	Limit value	Remark <sup>1)</sup>
Single 'J' bevel tee 	$G = 2.5 \div 4 \text{ mm}$		
Double bevel tee symmetrical 	$t > 19 \text{ mm}$ $G < 3 \text{ mm}$		
Double bevel tee asymmetrical 	$t > 19 \text{ mm}$ $G < 3 \text{ mm}$		
Double 'J' bevel tee symmetrical 	$G = 2.5 \div 4 \text{ mm}$		
<b>Note 1:</b> Plate edge preparation may be accepted or approved by PRS in accordance with item 7 of Reference Publications or other recognized standard accepted by PRS. For welding procedures other than manual welding, see paragraph 3.2 Qualification of weld procedures.			

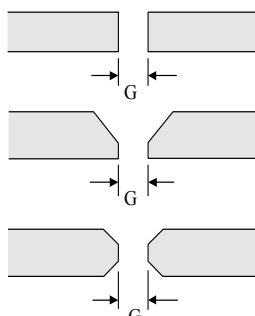
8.3 Butt and fillet weld profile (manual and semi-automatic welding) – see Table 8.3

**Table 8.3**  
Butt and fillet weld profile (manual and semi-automatic welding)

Detail	Standard value	Limit value	Notes
Butt weld toe angle 	$\theta < 60^\circ$ $h < 6 \text{ mm}$	$\theta < 90^\circ$	
Butt weld undercut 		$D < 0.5 \text{ mm}$ for strength members $D < 0.8 \text{ mm}$ for others	
Fillet weld leg length 		$s > 0.9s_d$ $a > 0.9a_d$ over short weld lengths	$s_d = \text{design } s$ $a_d = \text{design } a$
Fillet weld toe angle 		$\theta < 90^\circ$	In areas of stress concentration and fatigue, PRS may require a lesser angle.
Fillet weld undercut 		$D < 0.8 \text{ mm}$	

**8.4 Typical butt weld plate edge preparation (automatic welding) for reference – see Table 8.4**

**Table 8.4  
Typical butt weld plate edge preparation (automatic welding) for reference**

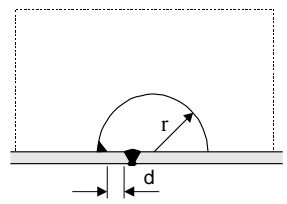
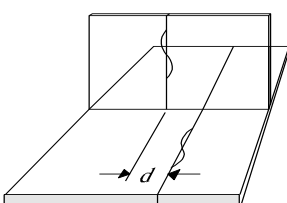
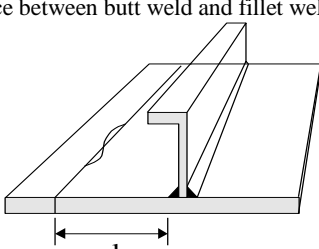
Detail	Standard value $G$ [mm]	Limit value $G$ [mm]	Notes <sup>1)</sup>
Submerged Arc Welding (SAW)  	0 ÷ 0.8	2	

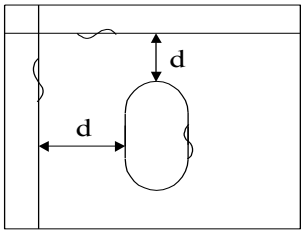
**Note 1:**

Plate edge preparation may be accepted or approved by PRS in accordance with item 7 of Reference Publications or other recognized standard accepted by PRS. For welding procedures other than manual welding, see paragraph 3.2 Qualification of weld procedures.

**8.5 Distance between welds - see Table 8.5**

**Table 8.5  
Distance between welds**

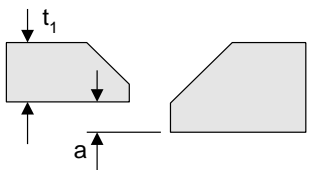
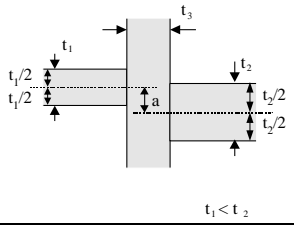
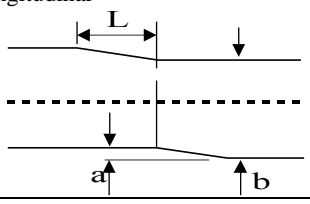
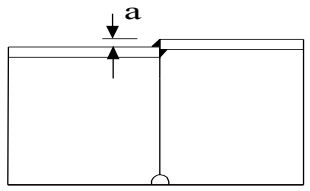
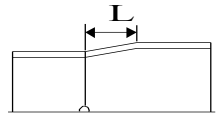
Detail	Standard value	Limit value	Notes
1	2	3	4
Scallops over weld seams  		for strength members: $d > 5$ mm. for others: $d > 0$ mm	The " $d$ " shall be measured from the toe of the fillet weld to the toe of the butt weld.
Distance between two butt welds  		$d > 0$ mm	
Distance between butt weld and fillet weld  		for strength members: $d > 10$ mm. for others: $d > 0$ mm	The " $d$ " shall be measured from the toe of the fillet weld to the toe of the butt weld.

1	2	3	4
Distance between butt welds 	for cut-outs $d > 30$ mm		
	for margin plates $d > 300$ mm	$d = 150$ mm	

## 9 REMEDIAL

### 9.1 Typical misalignment remedial - see Tables 9.1-1 to 9.1-3

**Table 9.1-1**  
**Typical misalignment remedial**

Detail	Remedia Standard	Notes
1	2	3
Alignment of butt joints 	Strength member $a > 0,15t_1$ or $a > 4$ mm release and adjust  Other $a > 0,2t_1$ lub $a > 4$ mm release and adjust	$t_1$ is lesser plate thickness
Alignment of fillet welds 	Strength member and higher stress member $t_1/3 < a \leq t_1/2$ – generally increase weld throat by 10%  $a > t_1/2$ – release and adjust over a minimum of 50a	Alternatively, heel line can be used to check the alignment. Where $t_3$ is less than $t_1$ then $t_3$ shall be substituted for $t_1$ in standard.
	Other: $a > t_1/2$ – release and adjust over a minimum of 30a	
Alignment of flange of T-longitudinal 	When $0,04b < a \leq 0,08b$ ( $a \leq 8$ mm) grind corners to smooth taper over a minimum distance $L = 3a$ . When $a > 0,08b$ or $a > 8$ mm release and adjust over a distance $L \geq 50a$ .	
Alignment of height of T-bar, L-angle bar or bulb 	When $3$ mm $< a \leq 6$ mm: build up by welding  When $a > 6$ mm: release and adjust over $L \geq 50a$ for strength member and $L \geq 30a$ for other 	



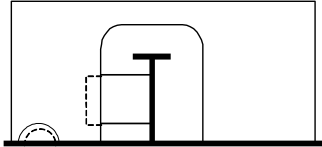
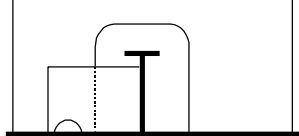
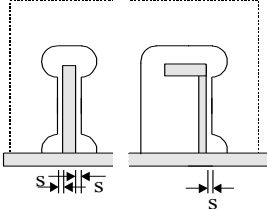
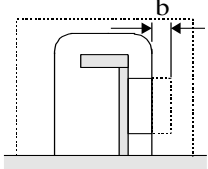
1	2	3
	<p>For <math>3 \text{ mm} &lt; a \leq 5 \text{ mm}</math> : weld length to be increased by the same amount as increase in gap in excess of <math>a - 3 \text{ mm}</math></p> <p>For <math>a &gt; 5 \text{ mm}</math>: members to be re-aligned.</p>	

**Table 9.1-2**  
**Typical misalignment remedial**

Detail	Remedial Standard	Notes
<p>Gap between bracket/intercostal and stiffener</p>	<p>When <math>3 \text{ mm} &lt; a \leq 5 \text{ mm}</math> weld leg length to be increased by increase in gap in excess of 3 mm</p> <p>When <math>5 \text{ mm} &lt; a \leq 10 \text{ mm}</math> – chamfer <math>30^\circ</math> to <math>40^\circ</math> and build up by welding with backing.</p> <p>When <math>a &gt; 10 \text{ mm}</math>: increase gap to about 50 mm and fit collar plate.</p> <p><math>t \geq t_1</math></p> <p><math>b = (2t + 25) \text{ mm}</math>, min. 50 mm</p>	
<p>Gap between beam and frame</p>	<p>When <math>3 \text{ mm} &lt; a \leq 5 \text{ mm}</math> weld leg length to be increased by the same amount as increase in gap in excess of 3 mm</p> <p>When <math>a &gt; 5 \text{ mm}</math> – release and adjust</p>	

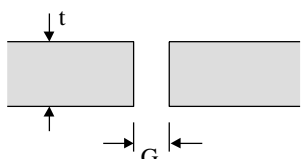
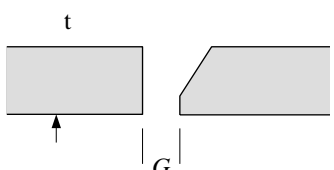
**Table 9.1-3**  
**Misalignment remedial**

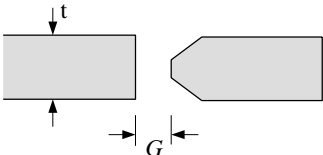
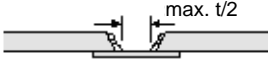
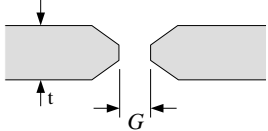
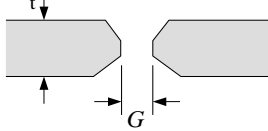
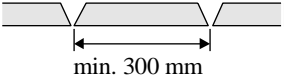
Detail	Remedial standard	Notes
1	2	3
<p>Position of scallop</p>	<p>When <math>d &lt; 75 \text{ mm}</math>, web plate to be cut between scallop and slot, and collar plate to be fitted</p> <p><math>b (\text{min. } 50 \text{ mm})</math></p>	

1	2	3
	<p>or fit small collar over scallop</p>  <p>or fit collar plate over scallop</p> 	
<p>Gap around stiffener cut-out</p> 	<p>When: <math>3 \text{ mm} &lt; s \leq 5 \text{ mm}</math> weld leg length to be increased by the same amount as increase in gap in excess of 2 mm.</p> <p>When: <math>5 \text{ mm} &lt; s \leq 10 \text{ mm}</math> nib to be chamfered and built up by welding.</p> <p>When: <math>s &gt; 10 \text{ mm}</math> cut off nib and fit collar plate of same height as nib.</p>  <p><math>20 \text{ mm} \leq b \leq 50 \text{ mm}</math></p>	

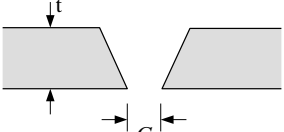
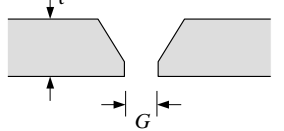

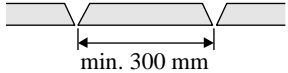
**9.2 Typical butt weld plate edge preparation remedial (manual and semi-automatic welding) - see Tables 9.2-1 i 9.2-2**

**Table 9.2-1  
Typical butt weld plate edge preparation remedial (manual and semi-automatic welding)**

Detail	Remedial standard	Notes <sup>1)</sup>
1	2	3
<p>Square butt – weld „I”</p> 	<p>When <math>G \leq 10 \text{ mm}</math>, chamfer to <math>45^\circ</math> and build up by welding.</p> <p>When <math>G &gt; 10 \text{ mm}</math>, build up with backing strip; remove, back gouge and seal weld; or, insert plate, min. width 300 mm.</p>	
<p>Single bevel butt – weld „1/2Y”</p> 	<p>When: <math>5 \text{ mm} &lt; G \leq 1,5 t</math> (maximum 25 mm) – build up gap with welding on one or both edges to maximum of <math>0.5t</math>, using backing strip, if necessary.</p> <p>Where a backing strip is used, the backing strip shall be removed, the weld back gouged, and a sealing weld made.</p>	

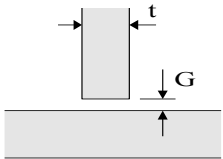
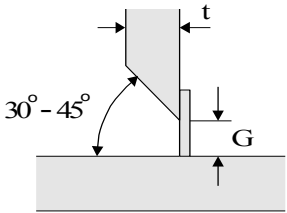
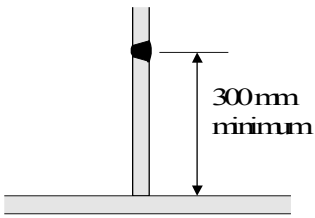
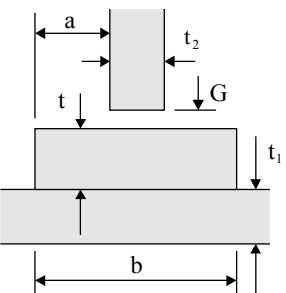
1	2	3
<p>Double bevel butt – weld „K”</p> 	 <p>Different welding arrangement by using backing material approved by PRS may be accepted on the basis of an appropriate welding procedure specification.</p>	
<p>Double vee butt, uniform bevels</p> 	<p>When <math>G &gt; 25</math> mm or <math>1.5 t</math> (whichever is smaller) – use insert plate, of minimum width 300 mm.</p>	
<p>Double vee butt, non-uniform bevel</p> 		
<p><b>Note 1:</b> Plate edge preparation may be accepted or approved by PRS in accordance with item 7 of Reference Publications or other recognized standard accepted by PRS.</p>		

**Table 9.2-2  
Typical butt weld plate edge preparation remedial (manual and semi-automatic welding)**

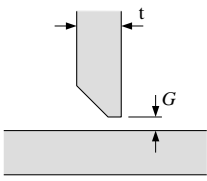
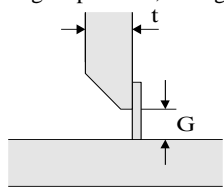
Detail	Remedial Standard	Notes <sup>1)</sup>
<p>Single vee butt, one side welding</p> 	<p>When: <math>5 \text{ mm} &lt; G \leq 1.5 t</math> (maximum 25 mm) – build up gap with welding on one or both edges. Limit" gap size preferably to "Standard" gap size as described in Table 8.1.2. Where a backing strip is used, the backing strip shall be removed, the weld back gouged, and a sealing weld made.</p>	
<p>Single vee butt, weld „Y”</p> 	<p>Different welding arrangement by using backing material approved by PRS may be accepted on the basis of an appropriate welding procedure specification.</p>  <p>Limits see Table 8.1.2. When <math>G &gt; 25</math> mm or <math>1.5 t</math> (whichever is smaller) – use insert plate of minimum width 300 mm.</p> 	
<p><b>Note 1:</b> Plate edge preparation may be accepted or approved by PRS in accordance with item 7 of Reference Publications or other recognized standard accepted by PRS.</p>		

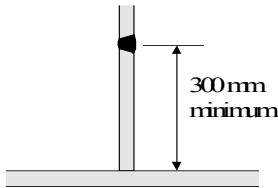
9.3 Typical fillet weld plate edge preparation remedial (manual and semi-automatic welding) - see Tables 9.3-1 do 9.3-3

**Table 9.3-1**  
**Typical fillet weld plate edge preparation remedial (manual and semi-automatic welding)**

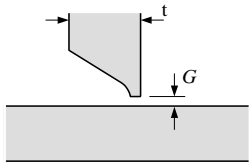
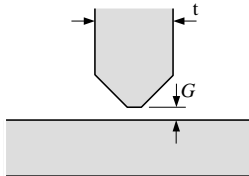
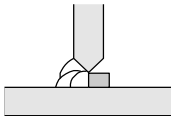
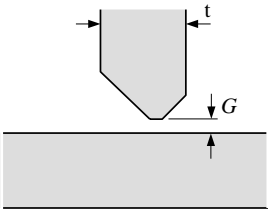
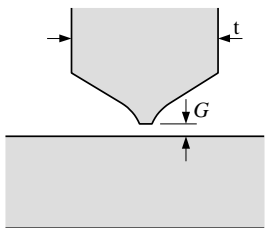
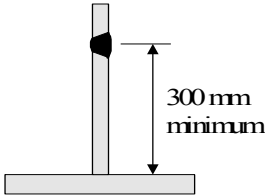
Detail	Remedial standard	Notes
	<p>When <math>3 \text{ mm} &lt; G \leq 5 \text{ mm}</math> – leg length increased to Rule leg + (G-2).</p> <p>When <math>5 \text{ mm} &lt; G \leq 16 \text{ mm}</math> or <math>G \leq 1.5t</math> – chamfer by <math>30^\circ</math> to <math>45^\circ</math>, build up with welding, on one side, with backing strip if necessary, grind and weld.</p>	
		
	<p>When <math>G &gt; 16 \text{ mm}</math> or <math>G &gt; 1.5t</math> (whichever is smaller) use insert plate of minimum width 300 mm.</p> 	
<p>Liner treatment</p> 	<p><math>t_2 \leq t \leq t_1</math>  <math>G \leq 2 \text{ mm}</math>  <math>a = 5 \text{ mm} + \text{fillet leg length}</math></p>	<p>Not to be used in cargo area or areas of tensile stress through the thickness of the liner.</p>

**Table 9.3-2**  
**Typical fillet weld plate edge preparation remedial (manual and semi-automatic welding)**

Detail	Remedial standard	Notes <sup>1)</sup>
1	2	3
<p>Single bevel tee</p> 	<p><math>3 \text{ mm} &lt; G \leq 5 \text{ mm}</math> – build up weld.</p> <p><math>5 \text{ mm} &lt; G \leq 16 \text{ mm}</math> – build up with welding, with backing strip if necessary, remove backing strip if used, back gouge and back weld.</p> 	

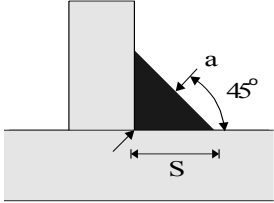
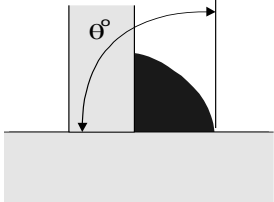
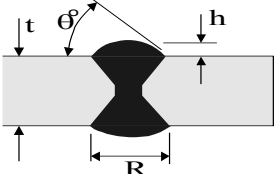
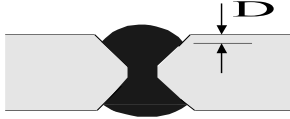
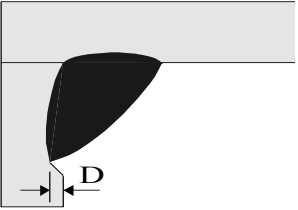
1	2	3
	<p><math>G &gt; 16 \text{ mm}</math> – new plate to be inserted of minimum width 300 mm.</p> 	
<p><b>Note 1:</b> Plate edge preparation may be accepted or approved by PRS in accordance with item 7 of Reference Publications or other recognized standard accepted by PRS.</p>		

**Table 9.3-3**  
**Typical fillet weld plate edge preparation remedial (manual and semi-automatic welding)**

Detail	Remedial standard	Notes <sup>1)</sup>
<p>Single 'J' bevel tee</p> 	as single bevel tee	
<p>Double bevel tee symmetrical</p> 	<p>When: <math>5 \text{ mm} &lt; G \leq 16 \text{ mm}</math> – build up with welding using ceramic or other approved backing bar, remove, back gouge and back weld.</p> 	
<p>Double bevel tee asymmetrical</p> 		
<p>Double 'J' bevel symmetrical</p> 		
<p><b>Note 1:</b> Plate edge preparation may be accepted or approved by PRS in accordance with item 7 of Reference Publications or other recognized standard accepted by PRS.</p>		

9.4 Typical fillet and butt weld profile remedial (manual and semi-automatic welding) - see Table 9.4

**Table 9.4**  
**Typical fillet and butt weld profile remedial (manual and semi-automatic welding)**

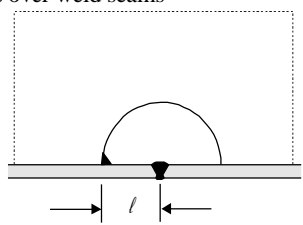
Detail	Remedial standard	Notes <sup>1),2)</sup>
<p>Fillet weld leg length</p> 	<p>Increase leg or throat by welding over.</p>	
<p>Fillet weld toe angle</p> 	<p>When <math>\theta &gt; 90^\circ</math> grinding, and welding, where necessary, to make <math>\theta &lt; 90^\circ</math></p>	
<p>Butt weld toe angle</p> 	<p>When <math>\theta &gt; 90^\circ</math> grinding, and welding, where necessary, to make <math>\theta &lt; 90^\circ</math></p>	
<p>Butt weld undercut</p> 	<p>For strength members, where <math>0.5 \text{ mm} &lt; D \leq 1 \text{ mm}</math> and for other, where <math>0.8 \text{ mm} &lt; D \leq 1 \text{ mm}</math>, undercut to be ground smooth (localized only) or to be filled by welding.            Where <math>D &gt; 1 \text{ mm}</math> – undercut to be filled by welding.</p>	
<p>Fillet weld undercut</p> 	<p>Where <math>0.8 \text{ mm} &lt; D \leq 1 \text{ mm}</math> – undercut to be ground smooth (localized only) or to be filled by welding.            Where <math>D &gt; 1 \text{ mm}</math> – undercut to be filled by welding.</p>	

**Notes:**

- 1) Plate edge preparation may be accepted or approved by PRS in accordance with item 7 of Reference Publications or other recognized standard accepted by PRS.
- 2) Minimum short bead – see Table 9.9.

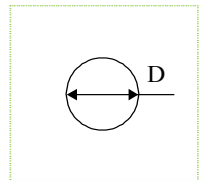
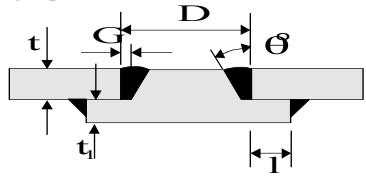
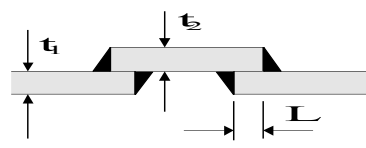
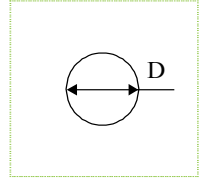
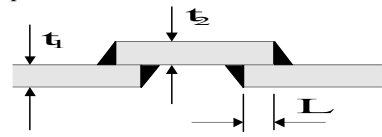
9.5 Distance between welds remedial – see Table 9.5

**Table 9.5**  
**Distance between welds remedial**

Detail	Remedial standard	Notes
Scallops over weld seams 	Hole to be cut and ground smooth to obtain distance.	<i>l</i> to be agreed with PRS

9.6 Erroneous hole remedial – see Table 9.6

**Table 9.6**  
**Erroneous hole remedial**

Detail	Remedial standard	Notes
Holes made erroneously $D < 200$ mm 	Strength members: open hole to minimum 75 mm dia., fit and weld spigot piece  $\theta = 30^\circ - 40^\circ$ $G = 4 - 6$ mm $\frac{1}{2}t < t_1 \leq t$ $l = 50$ mm or open hole to over 300 mm and fit insert plate.	Fillet weld to be made after butt weld. The fitting of spigot pieces in areas of high stress concentration or fatigue shall be approved by PRS.
	Other members – open hole to over 300 mm and fit insert plate or fit lap plate.  $t_1 = t_2 L = 50$ mm, min.	
Holes made erroneously $D \geq 200$ mm 	Strength members: open hole and fit insert plate. Other members – open hole to over 300 mm and fit insert plate or fit lap plate.  $t_1 = t_2 L = 50$ mm, min.	

**9.7 Remedial by insert plate – see Table 9.7**

**Table 9.7  
Remedial by insert plate**

Detail	Remedial standard	Notes
<p>Remedial by insert plate</p> <p>Existing welds</p>	<p><math>L = 300 \text{ mm min.}</math>  <math>B = 300 \text{ mm min.}</math>  <math>R = 5t \text{ mm, } 100 \text{ mm min.}</math></p> <p>In the case of inserting plate next to existing weld, the original seam shall be released over the length of the insert length plus 100 mm at both ends.</p> <p>(1) seam with insert piece shall be welded first                  (2) the original seam released shall be welded over for a minimum 100 mm at both ends of the insert plate.</p>	
<p>Remedial of built section by insert plate</p>	<p><math>L_{\min} \geq 300 \text{ mm}</math></p> <p>Welding sequence                  (1) → (2) → (3) → (4)</p> <p>Web butt weld scallop to be filled during final pass.</p>	

**9.8 Weld surface remedial – see Table 9.8.**

**Table 9.8  
Weld surface remedial**

Detail	Remedial standard	Notes
<p>Weld spatter</p>	<ol style="list-style-type: none"> <li>Remove spatter observed before blasting with scraper or chipping hammer, etc.</li> <li>For spatter observed after blasting:                             <ol style="list-style-type: none"> <li>remove with a chipping hammer, scraper, etc</li> <li>for spatter not easily removed with a chipping hammer, scraper, etc., grind the sharp angle of spatter to make it obtuse.</li> </ol> </li> </ol>	<p>In principle, no grinding is applied to weld surface</p>
<p>Arc strike (HT steel, Cast steel, Grade E of mild steel, TMCP type HT steel, Low temp steel)</p>	<p>Remove the hardened zone by grinding or other measures such as overlapped weld bead etc.</p>	<p>Minimum short bead to be referred Table 9.9.</p>



## 9.9 Welding remedial by short bead (see Table 9.9)

**Table 9.9**  
**Welding remedial by short bead**

Detail	Remedial standard	Notes
Short bead for remedying scar (scratch).	a) HT steel, Cast steel, TMCP type HT steel (CEV > 0.36%) and Low temp steel (CEV > 0.36%). Length of short bead ≥ 50 mm. b) Grade E of mild steel Length of short bead ≥ 30 mm. c) TMCP type HT steel (CEV < 0.36%) and Low temp steel (CEV < 0.36%) Length of short bead ≥ 10 mm.	Preheating is necessary at 100 ± 25°C.
Remedying weld bead	a) HT steel, Cast steel, TMCP type HT steel (CEV > 0.36%) and Low temp steel (CEV > 0.36%) Length of short bead ≥ 50 mm. b) Grade E of mild steel Length of short bead ≥ 30 mm. c) TMCP type HT steel (CEV < 0.36%) and Low temp steel (CEV < 0.36%) Length of short bead ≥ 30 mm.	
<p><b>Notes:</b></p> <p>1. When short bead is made erroneously, remove the bead by grinding.</p> <p>2. The carbon equivalent (CEV) for higher strength steel shall be calculated from the below formula:</p> $CEV = C + \frac{Mn}{6} + \frac{Cr + Mo + V}{5} + \frac{Ni + Cu}{15} \quad [%]$		

## **PART B**

### **REPAIR QUALITY STANDARD FOR EXISTING SHIPS**

#### **1 SCOPE**

**1.1** This *Publication* provides guidance on quality of repair of hull structures. The *Publication* covers permanent repairs of existing ships.

Whereas the *Publication* generally applies to:

- conventional ship types,
  - parts of hull covered by the *Rules* of PRS,
  - hull structures constructed from normal and higher strength hull structural steel,
- the applicability of the standard shall in each case be agreed upon by PRS.

The *Publication* does generally not apply to repair of:

- special types of ships as e.g. gas tankers,
- structures fabricated from stainless steel or other, special types or grades of steel.

**1.2** The *Publication* covers typical repair methods and gives guidance on quality standard on the most important aspects of such repairs. Unless explicitly stated elsewhere in the *Publication*, the level of workmanship reflected herein will in principle be acceptable for primary and secondary structure of conventional design. A more stringent standard may however be required for critical and highly stressed areas of the hull, and shall be agreed with PRS in each case. In assessing the criticality of hull structure and structural components, reference is made to *Additional publications* (see page 2).

**1.3** Restoration of structure to the original standard may not constitute durable repairs of damages originating from insufficient strength or inadequate detail design. In such cases strengthening or improvements beyond the original design may be required. Such improvements are not covered by this *Publication*, however it is referred to in additional publications (see page 2).

#### **2 GENERAL REQUIREMENTS FOR REPAIRS AND REPAIRERS**

**2.1** In general, when hull structure covered by classification shall be subjected to repairs, the work shall be performed under the supervision of the Surveyor to PRS. Such repairs shall be agreed prior to commencement of the work.

**2.2** Repairs shall be performed by workshops, repair yards or personnel who have demonstrated their capability to carry out hull repairs of adequate quality in accordance with PRS requirements and this *Publication*.

**2.3** Repairs shall be performed under working conditions that facilitate sound repairs. Provisions shall be made for proper accessibility, staging, lighting and ventilation. Welding operations shall be performed under shelter from rain, snow and wind.

**2.4** Welding of hull structures shall be performed by qualified welders, according to approved and qualified welding procedures and with welding consumables approved by PRS, see *References* item [3]. Welding operations shall be performed under proper supervision of the repair yard.

**2.5** Where repairs to hull which affect or may affect classification are intended to be performed during a voyage, complete repair procedure including the extent and sequence of repair shall be submitted to and agreed upon by the Surveyor to PRS reasonably in advance of the repairs, see *References*, item [1].

### **3 QUALIFICATION OF PERSONNEL**

#### **3.1 Qualification of welders**

**3.1.1** Welders shall be qualified in accordance with the binding standards concerning of welders qualification (e.g. EN 287-1 or ISO 9606-1). Recognition of qualification by other bodies based on these standards or other standards, such as AWS is subject to submission them to PRS for evaluation. Subcontractors shall keep records of welder's qualification and, when required, furnish valid approval test certificates.

**3.1.2** Welding operators using fully mechanised or fully automatic processes need generally not pass approval testing, provided that production welds made by the operators are of the required quality. However, operators shall receive adequate training in setting or programming and operating the equipment. Records of training and production test results shall be maintained on individual operator's files and records, and be made available to PRS for inspection when requested.

**3.2** Welding procedures shall be qualified in accordance with *Publication 74/P – Principles for Welding Procedure Qualification* or other recognized international or national standards (e.g. EN ISO 15607, EN ISO 15610, EN ISO 15611, EN ISO 15612, EN ISO 15613, EN ISO 15614-1 or EN ISO 15614-2). Recognition by other institution acc. to these standards or other standards e.g. AWS is subject to submission to PRS for evaluation. The welding procedure shall be supported by a welding procedure qualification record. The specification shall include the welding process, types of electrodes, weld shape, edge preparation, welding techniques and positions.

**3.3** Personnel performing non-destructive examination for the purpose of assessing quality of welds in connection with new construction covered by this *Publication*, shall be qualified in accordance with a recognized international or national qualification scheme (e.g. EN-ISO 9712). Records of operators and their current authorization shall be kept and made available to the Surveyor for inspection when requested.

**3.3.1** Personnel performing non destructive examination for the purpose of assessing quality of welds in connection with repairs covered by this standard, shall be qualified in accordance with PRS rules or to a recognized international or national qualification scheme. Records of operators and their current certificates shall be kept and made available to the Surveyor for inspection at request.

### **4 MATERIALS**

#### **4.1 General requirements for materials**

**4.1.1** The requirements for materials used in repairs are in general the same as the requirements for materials specified in PRS Rules for new constructions (see *References*, item [3]).

**4.1.2** Replacement material is in general to be of the same grade as the original approved material. Alternatively, material grades complying with recognized national or international standards may be accepted by PRS, provided such standards give equivalence to the requirements of the original grade or are agreed by PRS. For assessment of equivalency between steel grades, the general requirements and guidelines in 4.2 apply.

**4.1.3** Higher tensile steel shall not be replaced by steel of a lesser strength unless specially approved by PRS.

**4.1.4** Normal and higher strength hull structural steels are to be manufactured at works approved by PRS for the type and grade being supplied.

**4.1.5** Materials used in repairs shall be certified by PRS applying the procedures and requirements in the rules for new constructions. In special cases, and normally limited to small quantities, materials may be accepted on the basis of alternative procedures for verification of the material's properties. Such procedures are subject to agreement by PRS in each separate case.

## 4.2 Equivalency of material grades

**4.2.1** Assessment of equivalency between material grades shall at least include the following aspects:

- heat treatment/delivery condition,
- chemical composition,
- mechanical properties,
- tolerances.

**4.2.2** When assessing the equivalence between grades of normal or higher strength, hull structural steels up to and including grade E40 in thickness limited to 50 mm, the general requirements in Table 4.2.2 apply.

**Table 4.2.2**  
**Minimum extent and requirements to assessment of equivalency between normal or higher strength hull structural steel grades**

Items to be considered	Requirements	Comments
Chemical composition	Contents: <ul style="list-style-type: none"> <li>– C – equal or lower</li> <li>– P and S – equal or lower</li> <li>– Mn – approximately the same but not exceeding 1.6%</li> <li>– Fine grain elements; in same amount</li> <li>– Deoxidation practice required</li> </ul>	The sum of the elements, e.g. Cu, Ni, Cr and Mo shall not exceed 0.8%
Mechanical properties	<ul style="list-style-type: none"> <li>– Tensile strength; equal or higher;</li> <li>– Yield strength; equal or higher;</li> <li>– Elongation; equal or higher;</li> <li>– Impact energy; equal or higher at same or lower temperature, where applicable</li> </ul>	Actual yield strength shall not exceed PRS Rule minimum requirements by more than 80 MPa.
Delivery condition	– Same or better	Heat treatment in increasing order: <ul style="list-style-type: none"> <li>– as rolled (AR)</li> <li>– controlled rolled (CR)</li> <li>– normalised (N)</li> <li>– thermo-mechanically rolled (TM)<sup>1)</sup></li> <li>– quenched and tempered (QT)<sup>1)</sup></li> </ul> <sup>1)</sup> TM- and QT-steels are not suitable for hot forming.
Tolerances	– Same or stricter	Permissible under thickness tolerances: <ul style="list-style-type: none"> <li>– plates: 0.3 mm</li> <li>– sections: according to recognized standards.</li> </ul>

**4.2.3** Guidance on selection of steel grades to certain recognized standards equivalent to hull structural steel grades specified in PRS rules is given in Table 4.2.3.

**Table 4.2.3**  
**Guidance on steel grades comparable to the normal and high strength hull structural steel grades**

Steel grades according to PRS Rules							Comparable steel grades (1)				
Grade	Yield stress $R_{eH}$ min. [MPa]	Tensile strength $R_m$ [MPa]	Elongation after break A min. [%]	Test			ISO  EN 10025:1990 (2) ISO 4950-2:1995	EN  EN 10025 series:2004	ASTM  A 131 GB 712-2011	JIS  G 3106	
				temp. [°C]	Average impact energy for $t \leq 50$ mm [J], min.						
					L	T					
A	235	400 – 520	22	+20	–	–	Fe 360B	S235JR	A	SM400B	
B				0	27	20	Fe 360C	S235J0	B	SM400B, SM400C	
D				-20	27	20	Fe 360D	S235J2	D	–	
E				-40	27	20	–	S275NL, S275ML	E	–	
AH 27				265	400 - 530	22	0	–	–	Fe 430C	S275J0
DH 27	-20	27	20				Fe 430D	S275J2, S275N, S275M	–	–	
EH 27	-40	–	–				–	S275NL, S275ML	–	–	
AH 32	315	440 – 570	22	0	–	–	–	–	AH32	SM490B, SM490C	
DH 32				-20	31	22	–	–	–	DH32	–
EH3 2				-40	–	–	–	–	–	EH32	–
AH 36	355	490 – 630	21	0	–	–	Fe 510C	S355J0	AH36	SM520B, SM520C	
DH 36				-20	34	24	Fe 510D, E355DD	S355J2, S355N, S355M	DH36	–	
EH 36				-40	–	–	E355E	S355NL, S355ML	EH36	–	
AH 40	390	510 – 660	20	0	–	–	E390CC	S420N, S420M	AH40	SM570	
DH 40				-20	39	26	E390DD	S420N, S420M	DH40	–	
EH 40				-40	–	–	E390E	S420NL, S420ML	EH40	–	

**Note:**

(1) In selecting comparable steels from this table, attention shall be given to the requirements of Table 4.2.2 and the dimension requirements of the product with respect to PRS rules. Some steel grades as per national or international standard are defined with specified yield and tensile strength properties which depend on thickness. For thicknesses with tensile properties specified lower than those of the PRS Rules, case-by-case consideration shall be given with regards to design requirements.

(2) EN 10025:1990 is superseded by EN10025 series.

## 5 GENERAL REQUIREMENTS TO WELDING

### 5.1 Correlation of welding consumables with hull structural steels

**5.1.1** For the different hull structural steel grades welding consumables shall be selected in accordance with PRS Rules (see *References*, item [3]).

### 5.2 General requirements to preheating and drying out

**5.2.1** The need for preheating shall be determined based on the chemical composition of the materials, welding process and procedure and degree of joint restraint. These conditions shall be agreed with PRS.

**5.2.2** A minimum preheat of 50° C shall be applied when ambient temperature is below 0°C. Dryness of the welding zone is in all cases to be ensured.

**5.2.3** Guidance on recommended minimum preheating temperature for higher strength steel is given in Table 5.2.3. For automatic welding processes utilising higher heat input e.g. submerged arc welding, the temperatures may be reduced by 50° C. For re-welding or repair of welds, the stipulated values shall be increased by 25° C.

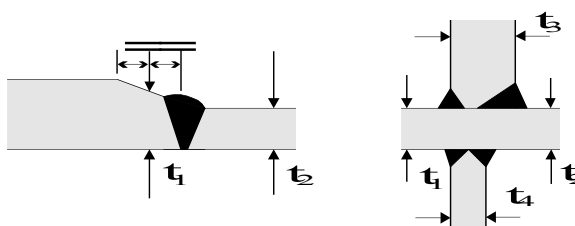
**Table 5.2.3**  
**Preheating temperature**

Carbon equivalent <sup>1)</sup>	Recommended minimum preheat temperature [°C]		
	$t_{comb} \leq 50 \text{ mm}^{2)}$	$50 \text{ mm} < t_{comb} \leq 70 \text{ mm}^{2)}$	$t_{comb} > 70 \text{ mm}^{2)}$
CEV $\leq 0.39$	–	50	
CEV $\leq 0.41$	–	75	
CEV $\leq 0.43$	–	50	100
CEV $\leq 0.45$	50	100	125
CEV $\leq 0.47$	100	125	150
CEV $\leq 0.50$	125	150	175

**Notes:**

1)  $CEV = C + \frac{Mn}{6} + \frac{Cr + Mo + V}{5} + \frac{Ni + Cu}{15}$ , [%]

2) Combined thickness  $t_{comb} = t_1 + t_2 + t_3 + t_4$ , see figures below.



### 5.3 Dry welding on hull plating below the waterline of vessels afloat

**5.3.1** Welding on hull plating below the waterline of vessels afloat is acceptable only on normal and higher strength steels with specified yield strength not exceeding 355 MPa and only for local repairs. Welding involving other high strength steels or more extensive repairs against water backing is subject to special consideration and approval by PRS of the welding procedure.

**5.3.2** Low-hydrogen electrodes or welding processes shall be used when welding on hull plating against water backing. Coated low-hydrogen electrodes used for manual metal arc welding shall be properly conditioned to ensure a minimum of moisture content.

**5.3.3** In order to ensure dryness and to reduce the cooling rate, the structure shall be preheated by a torch or similar prior to welding, to a temperature of minimum 5°C or as specified in the welding procedure.

## 6 REPAIR QUALITY STANDARD

### 6.1 Welding, general

Item	Standard	Limit	Notes
Material Grade	Same as original or higher		See para. 4
Welding Consumables	PRS Rules, Part IX (see References, item [3])	Approval according to equivalent international standard	
Groove / roughness	See note and Fig. 6.1	$d < 1.5$ mm	Grind smooth
Pre-Heating	See Table 5.2.3	Steel temperature not lower than 5°C	
Welding with water on the outside	See 5.3	Acceptable for normal and high strength steels	Moisture to be removed by a heating torch
Alignment	As for new construction		
Weld finish	PRS Rules and Publications (see References, item [3])		
NDE	PRS Rules and Publications (see References, items [3] and [14])	At random with extent to be agreed with attending surveyors	

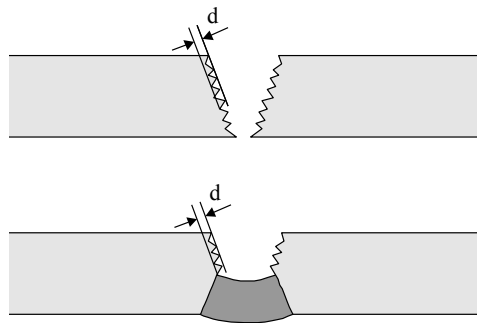


Fig. 6.1 Groove roughness

**Note:**

Slag, grease, loose mill scale, rust and paint, other than primer, to be removed.

### 6.2 Renewal of plates

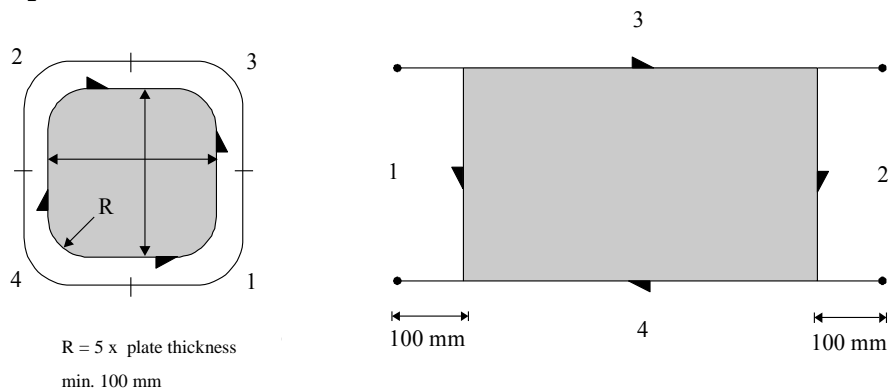


Fig. 6.2 Welding sequence for inserts

Item	Standard	Limit	Notes
Size insert	Min. 300 x 300 mm, $R = 5 \times$ plate thickness. Circular inserts: $D_{\min} = 200$ mm	Min. 200 x 200 mm Min. $R = 100$ mm	
Material grade	Same as original or higher		See para. 4
Edge Preparation	As for new construction		In case of non compliance increase the amount of NDE
Welding sequence	See fig.6.2 Weld sequence is: 1 $\rightarrow$ 2 $\rightarrow$ 3 $\rightarrow$ 4		For primary members sequence 1 and 2 transverse to the main stress direction
Alignment	As for new construction		
Weld finish	PRS Rules and Publications (see References, item [3])		
NDE	PRS Rules and Publications (see References, items [3] and [14])		

### 6.3 Doublers on plating

Local doublers are normally only allowed as temporary repairs, except as original compensation for openings, within the main hull structure.

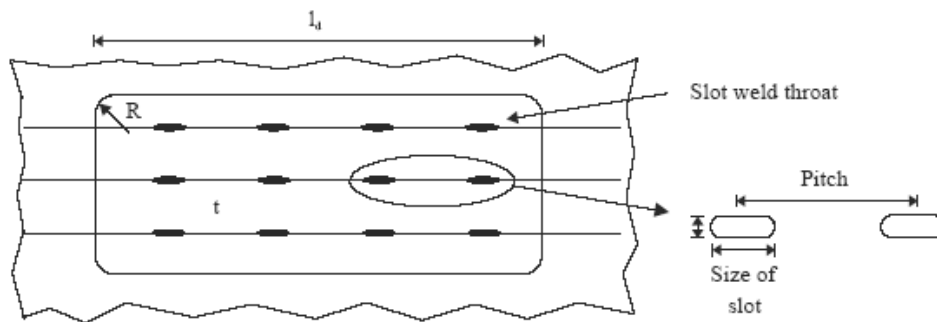


Fig. 6.3 Doublers on plates

Item	Standard	Limit	Notes
1	2	3	4
Existing plating		General: $t \geq 5$ mm	For areas where existing plating is less than 5 mm plating a permanent repair by insert shall be performed.
Extent/size	Rounded off corners	Min. 300 x 300 mm $R \geq 50$ mm	
Thickness of doubler ( $t_d$ )	$t_d \leq t_p$ ( $t_p$ – original thickness of existing plating)	$t_d > t_p/3$	
Material grade	Same as original plate		See para. 4
Edge preparation	As for new construction		Doublers welded on primary strength members ( $L_e$ : leg length) When $t > L_e + 5$ mm, the edge to be tapered (1 : 4)
Welding	As for new construction		Welding sequence similar to insert plates
Weld size(throat thickness)	Circumferential and in slots: $0.6 \times t_d$		



1	2	3	4
Slot welding	Normal size of slot: (80 – 100) x 2 t <sub>d</sub> . Distance from doubler edge and between slots: d ≤ 15 t <sub>d</sub>	Max pitch between slots : 200 mm d <sub>max</sub> = 500 mm	For doubler extended over several supporting elements, see figure 6.3
NDE	PRS Rules and Publications (see References, items [3] and [14])		

### 6.4 Renewal of internals/stiffeners

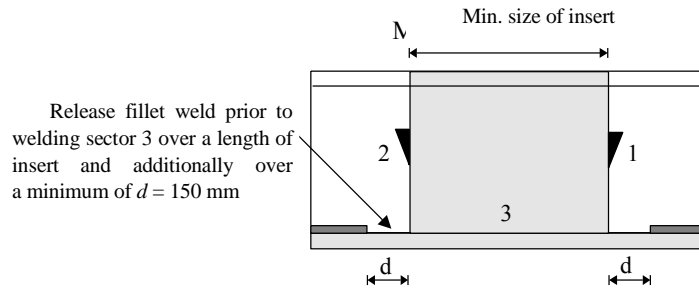


Fig. 6.4 Welding sequence for inserts of stiffeners

Item	Standard value	Limit value	Notes
Size insert	Min. 300 mm	Min. 200 mm	
Material grade	Same as original or higher		See para. 4
Edge Preparation	As for new construction. Fillet weld stiffener web/plate to be released over min. d = 150 mm		
Welding sequence	See Fig.6.4. Weld sequence is: 1 → 2 → 3		
Alignment	As for new construction		
Weld finish	PRS Rules (see References, item [3])		
NDE	PRS Rules and Publications (see References, items [3] and [14])		

### 6.5 Renewal of internals/stiffeners – transitions inverted angle/bulb profile

The application of the transition is allowed for secondary structural elements.

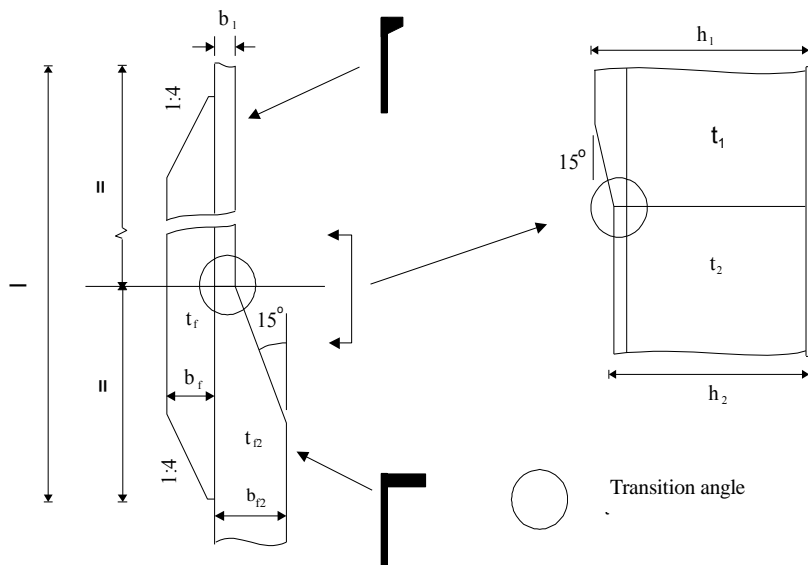


Fig. 6.5 Transition between inverted angle and bulb profile

Item	Standard value	Limit value	Notes
$(h_1 - h_2)$	$\leq 0.25 \times b_1$		
$(t_1 - t_2)$	2 mm		Without tapering transition
Transition angle	15 degrees		At any arbitrary section
Flanges	$t_f = t_2$ $b_f = b_2$		
Length of flatbar	$4 \times h_1$		
Material			See para. 4

### 6.6 Application of Doubling Straps

In certain instances, doubling straps are used as means to strengthen reinforce primary structure. Where this has been agreed and approved, special attention shall be paid to:

- the end termination points of the straps, so that toe support is such that no isolated hard point occurs,
- in the case of application of symmetrical or asymmetrical-ended straps, the corners at the end of the tapering shall be poetry rounded, see Fig. 6.6,
- any butts batwing lengths of doubling, so that these adequate separation of the butt weld from the primary structure below during welding, and so that a high quality rot run under controlled circumstances is completed prior to completing remainder of the weld. Ultrasonic testing shall be performed on completion to verify full penetration.

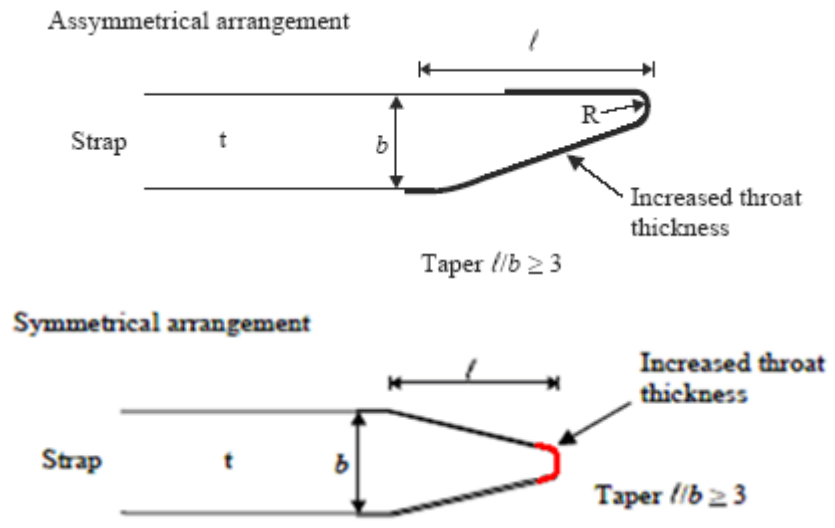


Fig. 6.6 Application of Doubling Straps

Item	Standard	Limit	Remarks
Tapering	$l/b > 3$		Special consideration to be drawn to design of strap terminations in fatigue sensitive areas.
Radius	$0.1 \times b$	min 30 mm	
Material			See paragraph 2.0 General requirement to materials.
Weld Size			Depending on number and function of straps. Throat thickness to be increased 15 % toward ends.
Welding	Welding sequence from middle towards the free ends		See sketch. For welding of lengths > 1000 mm step welding to be applied.

## 6.7 Welding of Pitting Corrosion

### Note:

Shallow pits may be filled by applying coating or pit filler. Pits can be defined as shallow when their depth is less than 1/3 of the original plate thickness.

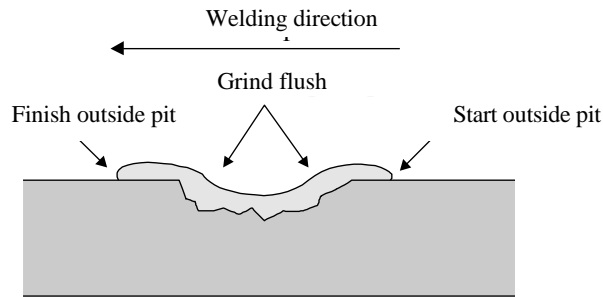


Fig. 6.7 Welding of pits

Item	Standard value	Limit value	Notes
Extent/depth	Pits/grooves shall be welded flush with the original surface	If deep pits or grooves are clustered together or remaining thickness is less than 6 mm, the plate shall be renewed	See also: PRS Rules (References, item. [3])
Cleaning	Heavy rust to be removed		
Pre-Heating	See Table 5.2.3	Required when ambient temperature < 5°C	Always use propane torch or similar to remove any moisture
Welding sequence	Reverse direction for each layer.		See also: PRS Rules (References, item. [3])
Weld finish	PRS Rules and Publications (see References, items [3] and [4])		
NDE	PRS Rules and Publications (see References, items [3] and [14])	Min. 10% extent	Preferably MPI

See also PRS Rules (References, items [5] and [7]).

## 6.8 Welding repairs for cracks

Where a crack is considered weldable, either as a temporary or permanent repair, the following techniques shall be adopted as far as practicable. Run-on and run-off plates shall be adopted at all free edges.

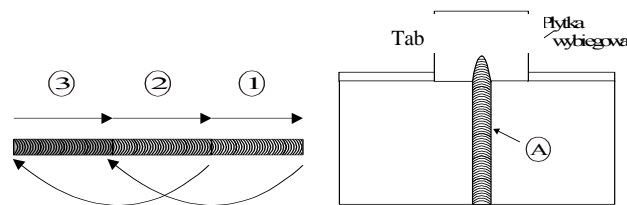


Fig. 6.8 a Step back technique

Fig. 6.8 b End crack termination

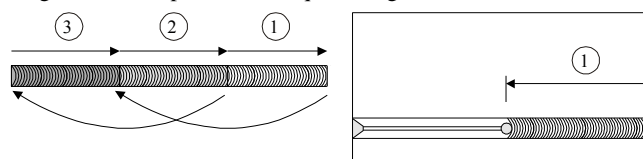


Fig. 6.8 c Welding sequence for cracks with length less than 300 mm

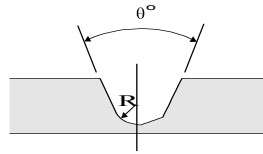


Fig. 6.8 d Groove preparation (U-groove left and V-groove right)

Item	Standard value	Limit value	Notes
Groove preparation	$\theta = 45 - 60^\circ$ $r = 5 \text{ mm}$		For through plate cracks as for newbuilding. Also see fig 6.8.d
Termination	Termination to have slope 1:3		For cracks ending on edges weld to be terminated on a tab see Fig 6.8.b
Extent	On plate max. 400 mm length. Vee out 50 mm past end of crack	On plate max 500 mm. Linear crack, not branched	
Welding sequence	See fig 6.8.c for sequence and direction	For cracks longer than 300 mm step-back technique shall be used Fig 6.8.a	Always use low hydrogen welding consumables
Weld finish	<i>PRS Rules and Publications</i> (see <i>References</i> , items [3] and [4])		
NDE	<i>PRS Rules and Publications</i> (see <i>References</i> , items [3] and [14])	100 % MP or PE of groove	100 % surface crack detection + UE or RE for butt joints

**Listing of Changes effective on the 1 July 2018**

<i>Item</i>	<i>Title/Subject</i>	<i>Source</i>
<a href="#">ADDITIONAL GUIDANCE</a>	Change - updating	Recommendation No.47, Rev.8
PART A <a href="#">Tables: 6.9, 6.11, 9.2-1, 9.2-2, 9.3-1, 9.3-2, 9.3-3,</a> PART. B <a href="#">Fig.6.3</a>	Updated acc. to Rec. No.47	User's remarks
PART B		
<a href="#">Table 4.2.3</a>	Change - updating	Recommendation No.47, Rev.8
<a href="#">Table 5.2.3</a>	Change - updating	Recommendation No.47, Rev.8
<a href="#">Fig. 6.6</a>	Added and change - updating	Recommendation No.47, Rev.8